



MM3-T Wireless Data Radios

MM3-T

Covering Firmware v11.00.13

User & Reference Manual



Warranty Information

FreeWave Technologies, Inc. warrants your FreeWave® Wireless Data Radio against defects in materials and manufacturing for a period of two years from the date of shipment, depending on model number. In the event of a Product failure due to materials or workmanship, FreeWave will, at its discretion, repair or replace the Product. For evaluation of Warranty coverage, return the Product to FreeWave upon receiving a Return Material Authorization (RMA).

IN NO EVENT WILL FREEWAVE TECHNOLOGIES, INC., ITS SUPPLIERS, OR ITS LICENSORS BE LIABLE FOR ANY DAMAGES ARISING FROM THE USE OF OR INABILITY TO USE THIS PRODUCT. THIS INCLUDES BUSINESS INTERRUPTION, LOSS OF BUSINESS INFORMATION, OR OTHER LOSS WHICH MAY ARISE FROM THE USE OF THIS PRODUCT. OEM CUSTOMER'S WARRANTY PERIODS CAN VARY.

Warranty Policy will **not apply** in the following circumstances:

1. If Product repair, adjustments, or parts replacements are required due to accident, neglect, or undue physical, electrical, or electromagnetic stress.
2. If Product is used outside of FreeWave specifications as stated in the Product's data sheet.
3. If Product has been modified, repaired, or altered by Customer unless FreeWave specifically authorized such alterations in each instance in writing. This includes the addition of conformal coating.

Safety Information

The products described in this manual can fail in a variety of modes due to misuse, age, or malfunction. Systems with these products must be designed to prevent personal injury and property damage during product operation and in the event of product failure.



Warning! Do not remove or insert the Ethernet or diagnostics cable while circuit is live unless the area is known to be free of ignition concentrations of flammable gasses or vapors.



Warning! Do not connect the MM3-LV-T, MM3-T series radios to DC power without terminating the antenna port to a suitable load, such as a 50 ohm antenna, or an attenuator with a power rating greater than or equal to 2 W. Powering up without a load attached will damage the radio and void the warranty.

FreeWave Technologies, Inc.
5395 Pearl Parkway, Suite 100
Boulder, CO 80301
303.381.9200
Toll Free: 1.866.923.6168
Fax: 303.786.9948

Copyright © 2018 by FreeWave Technologies, Inc.
All rights reserved.

www.freewave.com

Table Of Contents

Preface	7
1. Introduction	9
1.1. Choose a Radio Location	10
1.2. Choosing Point-to-Point or Point-to-MultiPoint Operation	10
1.2.1. Point-to-Point (PTP) Network	10
1.2.2. Point-to-MultiPoint (PTMP) Network	10
Differences between PTP and PTMP	11
1.3. Data Communication Link Examples	12
1.3.1. Example 1 - Point-to-Point Gateway to Endpoint	12
1.3.2. Example 2 - Gateway Repeater Endpoint	12
1.3.3. Example 3 - Two Repeaters	13
1.3.4. Example 4 - Multiple Radios	14
1.3.5. Example 5 - Point-to-MultiPoint	16
1.3.6. Example 6 - Point-to-MultiPoint with a Repeater Site	16
1.4. Finding the Product Serial Number	17
1.5. Identifying the Radio Model	18
1.5.1. MM3-T Model	18
1.7. Powering the Radio	19
1.8. Antenna Considerations	19
1.8.1. Antenna Location	19
1.9. Configuration Tool Options	20
1.9.1. Tool Suite and Terminal Emulators	21
1.10. Radio Setup Mode	21
1.10.1. Using Tool Suite to Connect to and Program Radios	22
1.10.2. Access the Setup Menu Using a Terminal Emulator	24
1.10.3. Connecting and Disconnecting from HyperTerminal	25
1.10.4. Troubleshooting HyperTerminal	25
Change the COM Port	26
Change the Baud Rate	27
Change the Flow Control	28
Change the Parity	29
1.11. Upgrade the Radios to the Latest Software Version	30
2. Basic Radio Programming and Setup	31
2.1. Setting the Radio's Role in the Network and the Network Type	31

2.2. Establishing Communication with Instrumentation and Computers	35
2.2.1. Baud Rate	35
2.2.2. Data Parity	36
2.2.3. Flow Control	36
2.2.4. Modbus RTU	37
2.2.5. Serial Interface	38
2.2.6. Setup Port	38
2.2.7. Turn Off Delay	38
2.2.8. Turn On Delay	38
2.2.9. Use Break to Access Setup	39
2.3. Establishing Communication with Other Radios in the Network	40
2.3.1. Golden Settings	41
2.4. Designate the RF Transmission Characteristics	41
2.4.1. 900MHz Channel Select Parameters	42
Access to the Single Channel Mask	44
Example of Single Channel Mask	45
2.4.2. 900MHz Frequency Key (Golden Setting)	45
2.4.3. 900MHz Frequency Zones	46
900MHz Frequency Zones Table	47
Enable Frequency Zones in Tool Suite	47
Enable Frequency Zones using the Terminal Interface	48
2.4.5. 900MHz Hop Table Size	49
2.4.6. 900MHz Hop Table Version	50
2.4.7. Max Packet Size and Min Packet Size (Golden Setting)	51
2.4.8. MCU Speed	52
2.4.9. Remote LED	53
2.4.10. Retry Time Out	53
2.4.11. RF Data Rate (Golden Setting)	54
2.4.12. RTS to CTS	54
2.4.13. Slave Security	56
2.4.14. Transmit Power	56
2.4.15. Transmit Rate	57
2.5. About Antennas	58
3. Configuring Point-to-MultiPoint Networks	61
3.1. Point to MultiPoint Network Characteristics	62
3.1.1. Golden Settings	62
3.1.2. Master to Slave Communications	62
3.1.3. Slave to Master Communications	62

3.2. Point-to-MultiPoint Network Quick Start	63
3.2.1. Point-to-MultiPoint Network Quick Start (Tool Suite)	63
3.2.2. Point-to-MultiPoint Network Quick Start (Terminal Interface)	64
3.3. Point-to-MultiPoint Operation LEDs	66
3.4. Overlapping MultiPoint Networks	67
3.5. Establishing Communication with Other Radios in a MultiPoint Network	67
3.5.1. Using the Network ID in MultiPoint Networks	67
3.5.2. Using the Call Book in MultiPoint Networks	68
3.5.3. Programming Point-to-MultiPoint Extended Call Book	69
3.6. Routing Communications through the Network	70
3.6.1. Assigning Subnet ID Values	70
Example 1: Subnet and Specific Path Communication	71
Example 2: Subnet and Communication Required through Repeaters	72
Example 3: Subnet and Optional Slave Communication	73
3.7. Setting Other MultiPoint Parameters	74
3.7.1. 1 PPS Enable Delay	74
Setup 1PPS Enable/Delay	74
Calibrate a Slave Radio in 1PPS Enable/Delay Mode	75
3.7.2. Diagnostics	75
3.7.3. DTR Connect	75
3.7.4. Local Mode	76
3.7.5. Master Packet Repeat	77
3.7.6. Master Packet Repeat in MultiPoint Networks with Repeaters	78
3.7.7. Max Slave Retry	78
3.7.8. Radio ID	78
3.7.9. Radio Name	79
3.7.10. Repeaters	79
3.7.11. Repeater Frequency	80
3.7.12. Retry Odds	80
3.7.13. Slave / Repeater	81
3.8. Reading Diagnostics in Tool Suite	82
4. Configuring Point-to-Point Networks	84
4.1. Point-to-Point Network Quick Start	84
4.1.1. Point-to-Point Network Quick Start (Tool Suite)	84
4.1.2. Point-to-Point Network Quick Start (Terminal Interface)	86
4.2. Point-to-Point Operation LEDs	88
4.3. Using the Call Book in Point-to-Point Networks	89
4.3.1. Setting the Call Book in Tool Suite	90

4.3.2. Setting the Call Book in the Terminal Interface	90
4.3.3. Programming Point-To-Point Extended Call Book to Use Three or Four Repeaters	92
5. Advanced Programming	93
5.1. Working with Parallel Repeaters	94
5.1.1. Repeaters Data Transmitted on the Same Frequency Key	94
5.1.2. Adding a Repeater to the Network	95
5.2. Setting and Changing Radio Passwords	96
5.2.1. Setting the Password	96
5.2.2. Changing a Password	96
5.2.3. Disable a Password	97
5.3. Enable and Set Up AES Encryption	97
5.3.1. Encryption (Strength)	98
5.3.2. Encryption Key	99
5.3.3. Encryption Channel Key	101
5.3.4. Troubleshooting AES Setup	101
5.4. Low Baud Rates	102
5.5. Multi-Master Sync	102
6. Viewing Radio Statistics	103
6.1. Antenna Reflected Power	104
6.2. Noise Level	104
6.3. Number of Disconnects	104
6.4. Radio Temperature	104
6.5. Rate % (Receive Percentage Rate)	104
6.6. Signal Level	105
6.7. Transmit Current	106
7. MM3-LV-T, MM3-T Wireless Data Radios Pinouts 7.1.	106
Operational RS422 Information	106
7.2. Pinout Assignments and Descriptions	106
7.3. MM3-T and MM3-LV-T Board-Level Pinout	107
8. Troubleshooting	109
8.1. Troubleshooting Flowchart	110
Appendix I: FreeWave Legal Information	121

Preface

Thank you for purchasing the FreeWave MM3-T Wireless Data Radios radio. This document applies to these models in the MM3 series:

- MM3-T

This document includes information about the FreeWave MM3-T serial radio:

- A basic introduction to the radio and how to determine the mode to run it in.
- Examples of how FreeWave radios can exist in a network with other radios.
- How to access the setup parameters available on the radio.
- Basic radio programming and setup information that applies to all network types.
- Considerations and quick starts for the network design, including charts of LED meanings.
- Details about defining a MultiPoint network including the use of Subnet IDs to route information through the network.
- Steps to view statistics about a radio's performance.
- Pinouts and mechanical drawings.

Product Sales and Professional Integration

The MM3 will only be available directly to OEMs and our reseller channels. OEMs will be able to integrate the MM3 into their product solution. We do not sell directly to end users. If you are not an OEM integrator, please reach out to your local Freewave sales reseller for a local integrator recommendation.

MM3 is designed for industrial/commercial applications only.

FreeWave has a radio certification program for our resellers that can be signed up for learning how to properly and professionally install all of Freewave products by contacting customer and technical support through the appropriate channels.

Contact FreeWave Technical Support

For up-to-date troubleshooting information, check the **Support** page at www.freewave.com. FreeWave provides technical support Monday through Friday, 8:00 AM to 5:00 PM Mountain Time (GMT -7).

- Call toll-free at 1.866.923.6168.
- In Colorado, call 303.381.9200.
- Contact us through e-mail at moreinfo@freewave.com.

Document Styles

This document uses these styles:

- FreeWave applications appear as: **FreeWave**.
- Parameter setting text appears as: **[Page=radioSettings]**
- File names appear as: **configuration.cfg**.
- File paths appear as: **C:\Program Files (x86)\FreeWave Technologies**.
- User-entered text appears as: **xxxxxxxxxx**.



Caution: Indicates a situation that **MAY** cause damage to personnel, the radio, data, or network.

Example: Provides example information of the related text.

FREEWAVE Recommends: Identifies FreeWave recommendation information.

Important!: Provides semi-cautionary information relevant to the text or procedure.

Note: Emphasis of specific information relevant to the text or procedure.



Tip Provides time saving or informative suggestions about using the product.



Warning! Indicates a situation that **WILL** cause damage to personnel, the radio, data, or network.

1. Introduction

FreeWave serial radios are DCE (Data Communications Equipment) radios that operate in virtually any environment where data communications occur. The radios act as data transmission devices, duplicating data in either Point-to-Point or Point-To-MultiPoint mode.



Figure 1: MM3-T

1.1. Choose a Radio Location

Placement of the FreeWave radio may have a significant impact on its performance. The key to the overall robustness of the radio link is the height of the antenna.

When using an external antenna, placement of that antenna is critical to a solid data link. Other antennas in close proximity are a potential source of interference.

Use the **Radio Statistics** to help identify potential problems. In general, FreeWave units with a higher antenna placement will have a better communication link.

In practice, the radio should be placed away from computers, telephones, answering machines, and other similar devices. The cable included with the radio provides ample distance for placement away from other equipment.

Note: FreeWave offers directional and Omni-directional antennas with cable lengths ranging from 3 to 200 feet.



An adjustment as little as 2 feet in antenna placement may resolve noise issues. In extreme cases, (e.g., Cellular Telephone tower interference) the band pass filters that FreeWave offers may reduce out-of-band noise.

1.2. Choosing Point-to-Point or Point-to-MultiPoint Operation

Important! For either a PTP or PTMP network, adding a Repeater cuts the network throughput by 50%.

1.2.1. Point-to-Point (PTP) Network

A PTP network work best when the network consists of one Master and one Slave radio.

Note: A maximum of four Repeaters can be added to extend the reach of the network.

1.2.2. Point-to-MultiPoint (PTMP) Network

In a PTMP network (also referred to as MultiPoint network) the Master radio is able to simultaneously communicate with numerous Slave radios.

- A MultiPoint network functions with the Master broadcasting its messages to all Slave radios.
- If requested by the Master, the Slave radios respond to the Master when given data by the device connected to the data port. The response depends on the setup.
- The network reach can be extended with as many Repeaters as is required.

Differences between PTP and PTMP

- In a Point-to-Point network all packets are acknowledged, whether sent from the Master to the Slave or from the Slave to the Master.
- In a MultiPoint network, the user determines the number of times outbound packets from the Master or Repeater to the Slave or other Repeaters are sent.
 - The receiving radio, Slave or Repeater, accepts the first packet received that passes the 32 bit CRC. However, the packet is NOT acknowledged.
 - On the return trip to the Master, all packets sent are acknowledged or retransmitted until they are acknowledged.
 - Therefore, the return link in a MultiPoint network is generally very robust.

Traditionally, a MultiPoint network is used in applications where data is collected from many instruments and reported back to one central site. The architecture of such a network is different from Point-to-Point applications. These parameters influence the number of radios that can exist in a MultiPoint network:

- Data block size.
 - The longer the data blocks, the fewer number of deployed Slave radios can exist in the network.
- Baud rate.
 - The data rate between the radio and the device it is connected to could limit the amount of data and the number of radios that can exist in a network
- The amount of contention between Slave radios.
- Polled Slave radios versus timed Slave radios.
- Repeater Use.
 - Using the **Repeater** setting in a Point-to-Point or MultiPoint network decreases overall network capacity by 50%.

Example: If the network polls once a day to retrieve sparse data, several hundred Slave radios could be configured to a single Master.

However, if each Slave transmits larger amounts of data or data more frequently, fewer Slave radios can link to the Master while receiving the same network performance.

When larger amounts of data are sent more frequently, the overall network bandwidth is closer to capacity with fewer Slave radios.

1.3. Data Communication Link Examples

- [Example 1 - Point-to-Point Gateway to Endpoint \(on page 13\)](#)
- [Example 2 - Gateway Repeater Endpoint \(on page 13\)](#)
- [Example 3 - Two Repeaters \(on page 14\)](#)
- [Example 4 - Multiple Radios \(on page 15\)](#)
- [Example 5 - Point-to-MultiPoint \(on page 16\)](#)
- [Example 6 - Point-to-MultiPoint with a Repeater Site \(on page 17\)](#)

1.3.1. Example 1 - Point-to-Point Gateway to Endpoint

The versatility of FreeWave radios allows data links to be established using a variety of different configurations.

This example shows the most common and straight forward link; a Master communicating to a Slave in a Point-to-Point link.

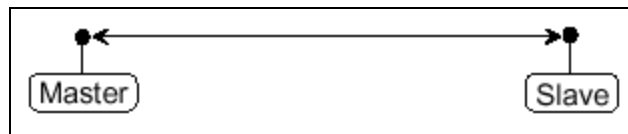

Figure 3: Master Communicating to a Slave in a Point-to-Point Link

1.3.2. Example 2 - Gateway Repeater Endpoint

This example shows a link using a Repeater.

- The Repeater may be located on a hilltop or other elevated structure enhancing the link from the Master to the Slave.
- In this configuration, it may be desirable to use an external Omni directional antenna at the Repeater.
- A Yagi antenna may be used at both the Master and Slave radios.

Note: Adding Repeaters to a network cuts the network throughput by 50%.

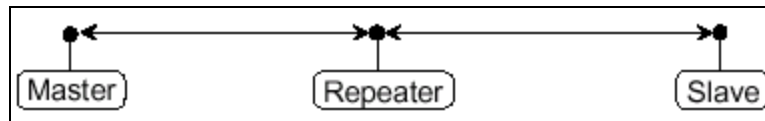

Figure 4: Master Communicating to a Slave in a Point-to-Point Link with a Repeater

1.3.3. Example 3 - Two Repeaters

This example shows a link with two Repeaters between the Master and Slave.

- With two Repeaters there is more flexibility in getting around obstacles and greater total range is possible.
- It may be desirable to use external Omni-directional antennas with the Repeaters, and attaching a Yagi antenna to the Master and Slave radio to increase the range of the link.
- When two Repeaters are used no further degradation in the RF throughput of the link is experienced.

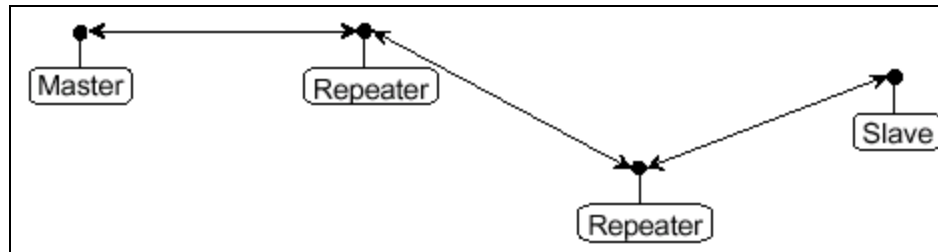

Figure 5: Master Communicating to a Slave in a Point-to-Point Link with Two Repeaters

1.3.4. Example 4 - Multiple Radios

This example shows a configuration where a Master radio routinely calls a number of Slave radios at different times.

- The Master radio is communicating with a radio designated as a Slave/Repeater that is connected to a remote device.
- Since this device is placed in an elevated location, the radio may also be used as a Repeater when it is not used as a Slave.
- At any time the Master may call any of the Slave radios, establish a connection, and send and receive data.

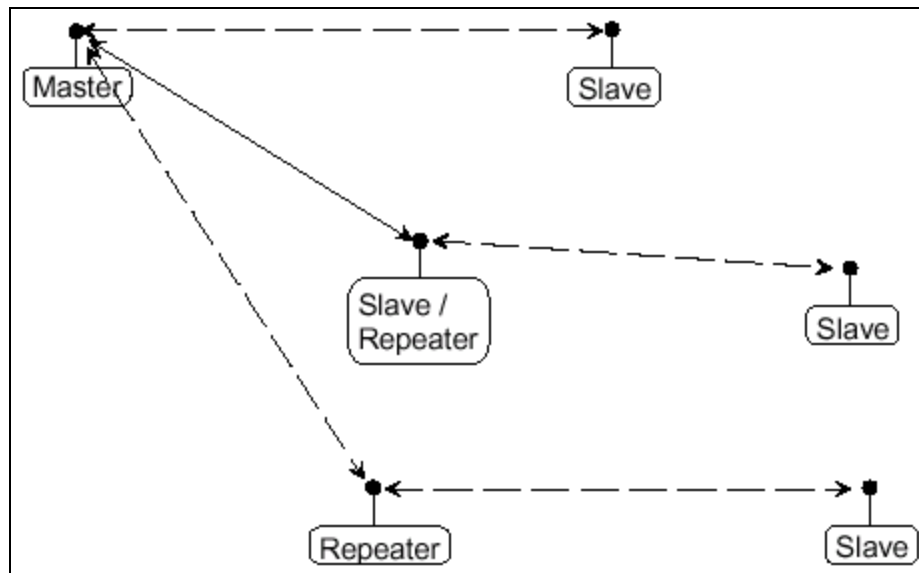

Figure 6: Master Communicating to Multiple Slave Radios at Different Times

1.3.5. Example 5 - Point-to-MultiPoint

This example illustrates a standard Point-to-MultiPoint network.

- From the Master, any data is broadcast to all three Slave radios, one of which receives it through a Multipoint Repeater.
- The data is sent out of the serial port of each of the three Slave radios.
- The end device should be configured to interpret the serial message and act on it if necessary.

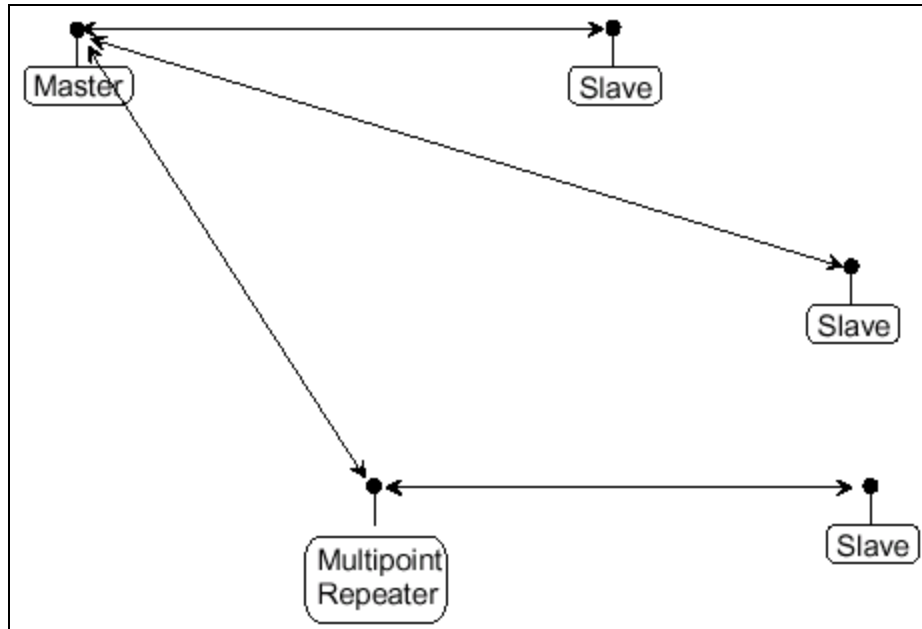

Figure 7: Master Communicating in a Point-to-MultiPoint Network

1.3.6. Example 6 - Point-to-MultiPoint with a Repeater Site

This example is a Point-to-MultiPoint network that uses one of the sites as a Slave/Repeater.

- This network functions in the same manner as a standard MultiPoint network with Repeaters.
- However, the number of radios may be reduced with the use of the MultiPoint Slave/Repeater feature.

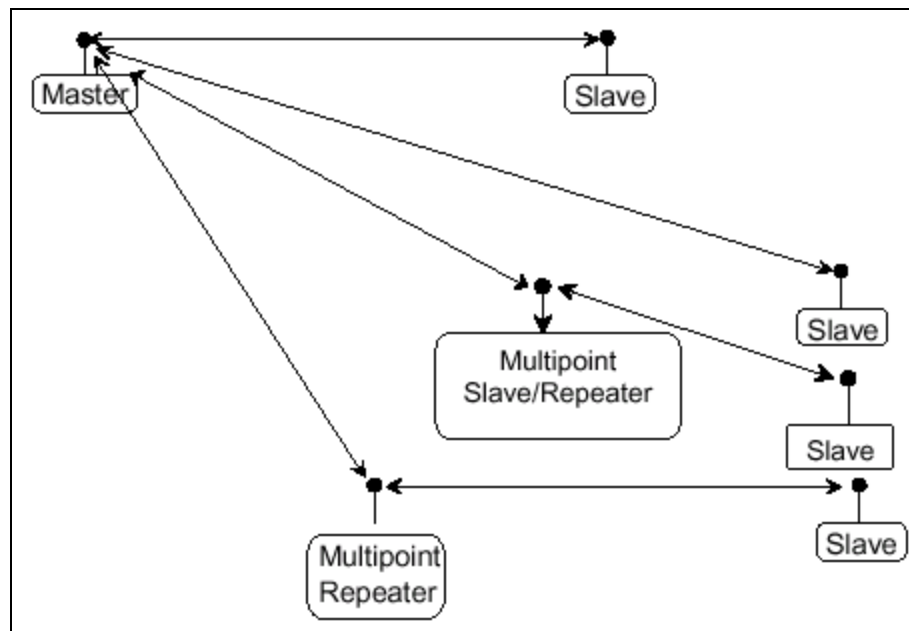

Figure 8: Master Communicating in a Point-to-MultiPoint Network using a Slave/Repeater

1.4. Finding the Product Serial Number

Each FreeWave radio is assigned a unique serial number.

Important! This number is needed to contact FreeWave Technical Support.

The serial number is three digits, followed by a hyphen, then four digits (e.g., 111-1111), and is printed on the FreeWave label on the radio.

Note: The example in this section is an image is of a GXM model.
The serial number information is in the same location on different models.

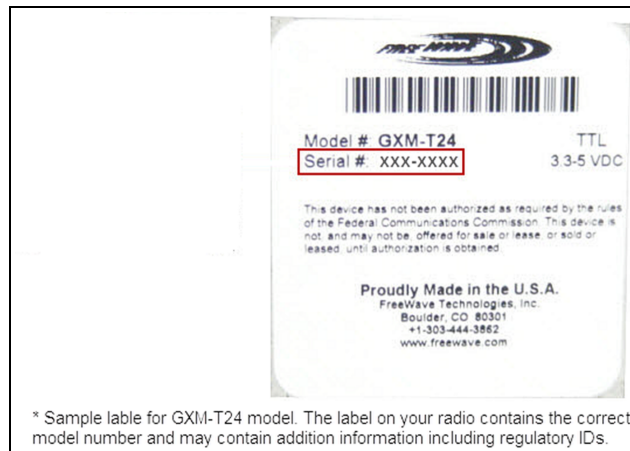

Figure 9: Example of the Serial Number for a GXM model

On radios that are not in an enclosure, the serial number is printed on a label on the back (the flat, smooth side) of the radio.

This label is in larger print.

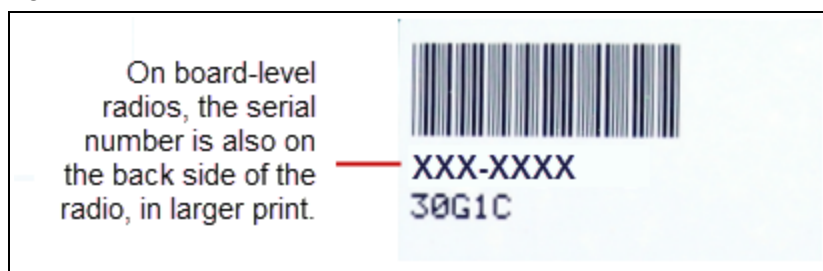

Figure 10: Example of the label and Serial Number of a non-enclosed radio

1.5. Identifying the Radio Model

This manual covers the configuration settings for the **MM3-T** models. There are slight differences in some of the settings for each model, and important differences in the power requirements between models. Each of these differences are described in detail where they apply in this manual.

To identify the radio model, look at these components:

- **Model number on the label**
 - The model number is printed on the FreeWave label on the radio.
- **Connector** - The serial connector on the radio helps to identify the model.
 - If the connector has 14 pins, the radio is an **MM3-T**.
- **Size**
 - The **MM3-T** models are the smaller of the two models, at 2 inches x 1.4 inches (50.8 mm x 36 mm).
 -

1.5.1. MM3-T Model

Note: The image is not to scale.

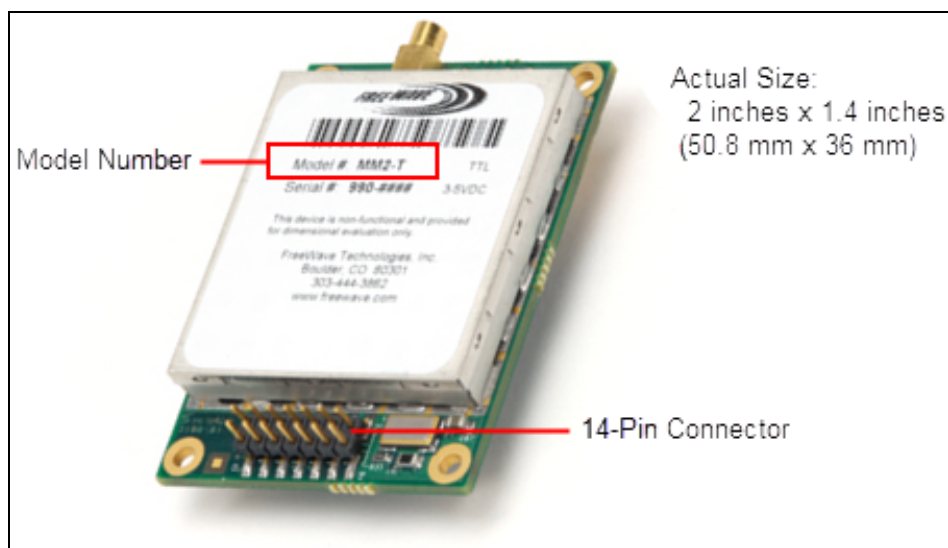

Figure 11: MM3-T Components

1.7. Powering the Radio

Connect the radio to a positive power supply with:

Model	Power Supply
MM3-T	+1.8 to +5.0 VDC

If the power supply line runs outside the enclosure, use:

- electrostatic discharge (ESD) protectors to protect the radio from electric shock.
- transient voltage suppressors (TVS) to protect from an over-voltage situation.



Using both helps enhances reliable operation.

1.8. Antenna Considerations

FreeWave offers many antenna options with cables in varying lengths. Consider the following antenna characteristics when choosing an antenna:

- Antenna radiation patterns / antenna type
- Cable loss
- Directionality
- Polarization
- Power gain



Warning! Radios with FCC ID KNYMM3 on the label are required to use only antennas with 12dBi gain or less.

1.8.1. Antenna Location

When using an external antenna, placement of the FreeWave radio's antenna is likely to have a significant impact on the radio's performance. The key to the overall robustness of the radio link is the height of the antenna. In general, FreeWave units with a higher antenna placement have a better communication link.

However, a higher antenna may pick up more RF noise in the area, and other antennas in close proximity could cause interference. An adjustment as little as 2 feet in antenna placement can

resolve some noise problems. In extreme cases, such as when interference is due to a pager or cellular tower, the band pass filters that FreeWave offers, may reduce this out-of-band noise.

Note: Use the **Radio Statistics**, available in option 4 in the main **Setup** menu of the radio to help identify problems.

Also consider the following points when locating antennas:

- Identify sites with clear Line of Sight.
- Long cable runs decrease signal and increase the amount of picked up noise.

Example: When using an LMR 400 cable on a 200 foot tower, loss in the cable run alone is 8 dB over the 200 foot distance.



To help optimize the antenna location, have FreeWave complete a Path Study. Complete and submit the Path Study form available from a FreeWave sales representative. Email the completed form to pathstudy@freewave.com.

1.9. Configuration Tool Options

When the radio is in **Setup** mode, use these setup tools to configure the settings on the radio:

- **Tool Suite**- Tool Suite is the recommended method for programming the radios.
 - It provides a group of tools for configuring the devices in the network and for monitoring the network's performance.
 - Use the **Configuration** application in Tool Suite to program changes to the radio's settings.
 - Tool Suite is available for download from www.freewave.com.

Note: For more information about using Tool Suite, see the **Tool Suite User Manual** in the Tool Suite software.

- **Terminal Emulator** - A terminal emulator program (e.g., HyperTerminal or Tera Term) offers many of the same configuration options available in the **Configuration** application in Tool Suite.
 - If running versions of the Windows® operating system prior to Windows® 7, HyperTerminal is included in the operating system installation.



Use the **Setup Terminal** application in Tool Suite to use and view the terminal menus. It shows the same menus and provides the same programming settings as you see using a terminal emulator.

For OEMs and engineering firms that want to integrate the MM3-T into their product, these approaches can be used for programming the MM3-T.

1.9.1. Tool Suite and Terminal Emulators

If using a terminal emulator, the tabs for a device in Tool Suite mirror the **Setup** main menu selections.

Example: Option 0 on the **Setup** main menu in the terminal menu setup is **Set Operation Mode**. The corresponding configuration tab for the device in Tool Suite is **(0) Operation Mode**.

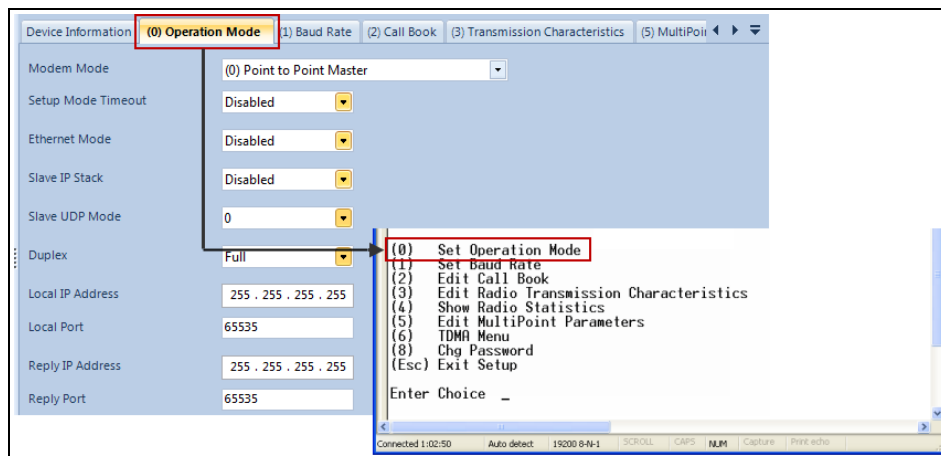

Figure 14: Tool Suite menu Matched to Terminal menu



Use the **Setup Terminal** application in Tool Suite to use and view the terminal menus. It shows the same menus and provides the same programming settings as you see using a terminal emulator.

Note: In this document, if the setup procedure in the terminal emulator is different than the procedure in Tool Suite, the terminal instructions are also included.

1.10. Radio Setup Mode

To read the current settings from or to program a radio, the radio must be in **Setup** mode. When a radio is in **Setup** mode, all three LEDs appear solid green ■ ■ ■. These sections provide details about how to access the radio's **Setup** mode using Tool Suite or the terminal interface.

Note: OEM boards may also enter **Setup** when Pin 2 on a 10- or 14-pin connector or Pin 8 on a 24-pin connector is grounded, or using a break command. For information about the break command, see [Use Break to Access Setup \(on page 42\)](#).

- The **Setup Port** parameter on the **Baud Rate** tab determines whether the main data port or the diagnostics port is used to access the setup parameters for the radio. For more information, see [Setup Port \(on page 41\)](#).

- Use the **Setup Mode Timeout** parameter on the **Operation Mode** tab to set the radio to exit **Setup Mode** automatically. When the setting is enabled, if the radio has not received any menu selections or programming information within 5 seconds, it exits **Setup** and resumes its previous mode.

Note: For **Setup** mode troubleshooting information, see [Troubleshooting \(on page 112\)](#).

1.10.1. Using Tool Suite to Connect to and Program Radios

To read and program a radio using Tool Suite, connect the radio to a computer that runs the Tool Suite software.



Use Tool Suite to set up a template version of a radio. Templates include settings that apply to more than one radio in the network.

Note: For more information about using templates, see the Tool Suite **User Manual** in the Tool Suite software.

Procedure

1. Connect a serial or diagnostic cable between the computer and the radio.

FREEWAVE Recommends: Using a diagnostic cable and the diagnostic port.

2. Connect the power supply to the radio and the power source and turn on the radio.
3. Open Tool Suite.
4. In the **Applications** window, click **Configuration** to open the **Configuration** application.
5. Verify the correct port is selected in the **Com Port** field on the **Configuration** ribbon.
6. Place the radio in **Setup** mode.
7. Short **Pin 2** to ground.

8. If using a data cable (FreeWave part number: **ASC3610DB** or **ASC3610DJ**), press the **Setup** button on the data cable.

Note: If using the **Setup Terminal** application or a terminal emulator and using the gray ribbon diagnostic cable (part number **AC2009DC**), or the black diagnostic cable (part number **ASC0409DC**), the radio changes to **Setup mode** automatically when **Read Radio** is clicked in Tool Suite.

All three LEDs on the radio are green  and stay green as long as the radio is in **Setup** mode.

9. On the **Configuration** ribbon, click **Read Radio** to read the radio's current settings.
10. Make the necessary parameter changes.
11. On the **Network Title ribbon**, use one of these options to send the changes to the radio:
 - Click **Quick** to send only the changed parameters.

Note: This option is only available if **Read Radio** is clicked and parameter settings are NOT sent from a template to the radio.

- Click **All** to send all the settings for all parameters.
- Click **Default** to set a device back to its factory default settings.

Note: For more information about using Tool Suite, see the **Tool Suite User Manual** in the Tool Suite software.

1.10.2. Access the Setup Menu Using a Terminal Emulator

This procedure accesses the radio's **Setup** menu using the **Setup Terminal** application in Tool Suite.

Note: For more information about using Tool Suite, see the **Tool Suite User Manual** in the Tool Suite software.

Procedure

1. Plug a serial cable into the COM 1 port on the radio.
2. Connect the cable to a COM port on the computer running Tool Suite.
3. Connect the radio to a power source.
4. Open Tool Suite.
5. On the **Applications** window, click **Setup Terminal**.
6. Click the **Connection** list box arrow in the top left of the window and select the COM port on the computer the radio is connected to.

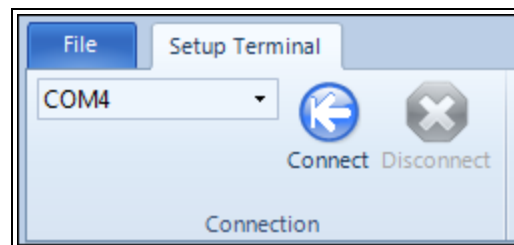

Figure 17: Connection list box

7. Click **Connect**.
8. Place the radio in **Setup** mode.
9. Short **Pin 2** to ground.

10. If using a data cable (FreeWave part number: **ASC3610DB** or **ASC3610DJ**), press the **Setup** button on the data cable.

Note: If using the **Setup Terminal** application or a terminal emulator and using the gray ribbon diagnostic cable (part number **AC2009DC**), or the black diagnostic cable (part number **ASC0409DC**), the radio changes to **Setup mode** automatically when **Read Radio** is clicked in Tool Suite.



All three LEDs on the radio are green ■ ■ ■ and stay green as long as the radio is in **Setup** mode.

Important! When navigating through the Setup menu and making changes to the parameters, the parameters are sent **immediately** to the radio.

1.10.3. Connecting and Disconnecting from HyperTerminal

The HyperTerminal dialog box has several toolbar buttons.

To reconnect to HyperTerminal, disconnect from the current session.

1. Click the **Disconnect** .
2. Click the **Call**  to reconnect.

Note: If the settings have not been saved they must be re-selected when HyperTerminal reconnects to the radio.

1.10.4. Troubleshooting HyperTerminal

These are some common issues encountered while using HyperTerminal as the terminal emulator.

- The steps to resolve the issue are specific to the HyperTerminal interface.
- Similar steps can be used when troubleshooting other terminal emulators.

Important! When a change is made to the HyperTerminal settings in an open terminal session, the connection must be disconnected then reconnected before the settings take effect.



- [Change the COM Port \(on page 29\)](#).
- [Change the Baud Rate \(on page 30\)](#).
- [Change the Flow Control \(on page 31\)](#).
- [Change the Parity \(on page 32\)](#).

Change the COM Port

Important! Nothing appears on the screen after placing the radio into Setup mode.

This error usually indicates one of two things:

- The wrong COM port is selected.
- A null modem cable is being used.

1. Click .
2. On the **File** menu, click **Properties**.
3. Click the **Connect To** tab.
4. Verify the correct COM port is selected.
5. Click **OK** to close the **Properties** dialog box.
6. Click .
7. Return the radio to **Setup** mode.
The Setup menu screen appears.



If the radio has been previously configured, the wrong port could be used to access the **Setup** menu.

Note: For more information, see [Setup Port \(on page 41\)](#). Try connecting to the other port.

Change the Baud Rate

Important! Unrecognizable characters appear on the screen after placing the radio into Setup mode.

- Unrecognizable characters usually indicate a **Baud Rate** problem.
- The problem may also be that the radio under test is a TTL version or has been set to RS485 and not RS232. If the radio is TTL or in RS485 mode, verify connection through the Diagnostic port. Gibberish before the **Setup** button is pressed indicates Diagnostics is enabled in a Master.



1. Click .
2. On the **File** menu, click **Properties**.
3. Click **Configure**.
4. Change these settings and click **OK**:
 - **Baud Rate** to **19200**
 - **Data Bits** to **8**
 - **Parity** to **None**
 - **Stop Bits** to **1**
 - **Flow Control** to **1**
5. Click **OK** to close the **Properties** dialog box.
6. Click .
7. Return the radio to **Setup** mode.
The **Setup** menu screen appears.

Change the Flow Control

Important! The Setup menu appears on the screen, but nothing happens when keys on the keyboard are pressed.

- This error usually indicates flow control is turned on in a three-wire connection (Rx, Tx, and Gnd).



Follow these steps if the connection uses a three-wire connection.

1. Click .
2. On the **File** menu, click **Properties**.
3. Click **Configure**.
4. Change the **Flow Control** to **None**, and click **OK**.
5. Click **OK** to close the **Properties** dialog box.
6. Click .
7. Return the radio to **Setup** mode.
The **Setup** menu screen appears.

Change the Parity

Important! A connection exists, the terminal emulator is receiving data, and some data is correct, but the remaining data is in unrecognizable characters.

- This error usually indicates a parity mismatch.
 - To resolve this issue, verify the parity of the radio and the parity of HyperTerminal are set the same.
- HyperTerminal's parity settings are under the **Properties** menu.
- The FreeWave radio parity is found under the **Baud Rate menu** in the **Setup** menu.

1. In HyperTerminal, click .
2. On the **File** menu, click **Properties**.
3. Click **Configure**.
4. Change the **Parity** to **None**, and click **OK**.
5. Click **OK** button to close the **Properties** dialog box.
6. Click .
7. Return the radio to **Setup** mode.
The **Setup** menu screen appears.

1.11. Upgrade the Radios to the Latest Software Version

If Tool Suite is connected to a radio, and a new version of the software is available for that radio model, an indication appears in the **Configuration** application's **Device Information** tab.

Use Tool Suite to upgrade the software on a serial radio connected directly to the computer using the diagnostic cable.

Important! An over-the-air upgrade using Tool Suite is not allowed.

FREEWAVE Recommends: If using a USB-to-serial converter cable, a software upgrade can take a long time to complete.

Use USB-to-serial cables that include the FTDI Chip Set to shorten the upgrade time.

This inclusion is listed on the cable's packaging.

See the **Application Note #5471 Optimizing Firmware Upgrade Speed While Using a USB-Serial Adaptor** for additional information (available at www.freewave.com).

Note: For more information about using Tool Suite, see the **Tool Suite User Manual** in the Tool Suite software.

Procedure

1. With the radio connected to the computer through the COM port, open Tool Suite.
2. In the **Applications** window, click **Configuration** to open the **Configuration** application.
3. In the **Firmware** area of the **Configuration** application, click **Upgrade Radio**.
4. Click **Yes** at the prompt to proceed.
Tool Suite identifies the software version loaded on the connected device and shows the latest version of software available for that model.
5. Click **Yes** to continue with the upgrade.
The system shows the progress of the software upgrade.
After the firmware upgrade is complete, a message appears confirming that the software upgrade was successful.

2. Basic Radio Programming and Setup

When setting up either a Point-to-MultiPoint network or a Point-to-Point network, the process for setting up and programming a radio is the same.

This section describes these aspects of programming and setting up a radio:

- [Setting the Radio's Role in the Network and the Network Type \(on page 35\)](#).
- [Establishing Communication with Instrumentation and Computers \(on page 38\)](#).
- [Establishing Communication with Other Radios in the Network \(on page 43\)](#).
- [Designate the RF Transmission Characteristics \(on page 44\)](#).

2.1. Setting the Radio's Role in the Network and the Network Type

Networks consist of a Master radio and any number of other components including Repeaters, Slave radios, and radios that act as both a Slave and a Repeater. The first parameter to set in a radio is its **Operation** or **Modem** mode.

The mode tells the radio what network type it is in (Point-to-Point or Point-to-MultiPoint) and what role it plays (Master, Slave, or Repeater) in that network.

Note: The network type must match for all radios in a network.

If configuring a Point-to-MultiPoint network, verify the **Modem Mode** selection for radios in the network starts with Point-to-MultiPoint.



When setting up the radio, remember that the settings on the Master control a number of parameters. Therefore, deploying the Master on the communications end where it is easier to access is advised, but not necessary.

Set the **Modem** mode on the **Operation Mode** tab, using the **Modem Mode** field. These settings are available in the **Operation Mode** menu in the terminal interface.

Operation Mode	Description
Point-to-Point Master (0)	<p>This mode designates the radio as the Master in Point-to-Point mode. The Master may call any or all Slaves designated in its Call Book.</p> <p>In Point-to-Point mode the Master determines the setting used for most of the transmission characteristics, regardless of the settings in the Slave and/or Repeaters.</p> <p>The settings NOT determined by the Master are:</p> <ul style="list-style-type: none"> • Hop Table settings • Retry Time Out • Slave Security • Transmit Power <p>A quick method of identifying a Master is to power the radio. Prior to establishing a link with a Slave, all three of the LEDs on the Master are solid red ■ ■ ■.</p>

2. Basic Radio Programming and Setup

MM3-T
User & Reference Manual

Operation Mode	Description
Point-to-Point Slave (1)	<p>This mode designates the radio as a Slave in Point-to-Point mode.</p> <ul style="list-style-type: none"> The Slave communicates with any Master in its Call Book - either directly or through a maximum of four Repeaters. When functioning as a Slave, the Entry to Call feature in the radio's Call Book is NOT operational. Set the Slave Security parameter to 1 to bypass the Call Book in the Slave. <div style="border: 1px solid black; padding: 5px; margin-top: 10px;"> <p>Note: For more information, see Slave Security on page 59.</p> </div>
Point-to-MultiPoint Master (2)	<p>This mode designates the radio as a Master in MultiPoint mode.</p> <ul style="list-style-type: none"> This mode allows one Master radio to communicate simultaneously with numerous Slaves and Repeaters. A Point-to-MultiPoint Master communicates only with other radios designated as Point-to-MultiPoint Slaves or Point-to-MultiPoint Repeaters.
Point-to-MultiPoint Slave (3)	<p>This mode designates the radio as a Slave in MultiPoint mode.</p> <ul style="list-style-type: none"> This mode allows the Slave to communicate with a MultiPoint Master. The Slave may communicate with its Master through one or more Repeaters.
Point-to-Point Slave / Repeater (4)	<p>This mode designates the radio to act as either a Slave or Repeater, depending on the instructions from the Master.</p> <ul style="list-style-type: none"> The radio cannot act as both a Slave and a Repeater at the same time. True Slave/Repeater functionality is only available in a MultiPoint mode. Point-to-Point Slave/Repeaters have no security features. When a radio is designated a Point-to-Point Slave/Repeater, it allows any Master to use it as a Repeater. <div style="border: 1px solid black; padding: 5px; margin-top: 10px;"> <p>Note: Adding Repeaters to a network cuts the network throughput by 50%.</p> </div>

2. Basic Radio Programming and Setup

MM3-T
User & Reference Manual

Operation Mode	Description
Point-to-Point Repeater (5)	<p>FreeWave allows the use of a maximum of four Repeaters in a Point-to-Point communications link, significantly extending the operating range.</p> <ul style="list-style-type: none"> • When designated as a Repeater, a radio behaves as a pass-through link. • All settings for the Call Book, baud rates, and transmission characteristics are disabled. • A Repeater connects with any Master that calls it. • The Repeater must be set up properly in the Master's Call Book. <p>Note: Adding Repeaters to a network cuts the network throughput by 50%.</p>
Point-to-Point Slave / Master Switchable (6)	<p>Mode 6 allows the radio to be controlled entirely through software commands.</p> <ul style="list-style-type: none"> • A number of key parameters in the FreeWave user interface may be changed either directly using a terminal emulator or using script files. • When the Point-to-Point Slave/Master Switchable option is selected and the radio is not calling a Slave, it functions as a Slave and accepts any appropriate calls from other radios. <p>Note: For more information, see Application Note #5476, Mode 6.</p>
Point-to-MultiPoint Repeater (7)	<p>This option allows the radio to operate as a Repeater in a MultiPoint network.</p> <ul style="list-style-type: none"> • A MultiPoint network can have as many Repeaters as necessary. • If the Repeater is to act as a Slave/Repeater, set the Slave Repeater parameter in the MultiPoint Parameters tab to Enabled. <p>Note: Adding Repeaters to a network cuts the network throughput by 50%.</p>
Mirrorbit Master (A) Mirrorbit Slave (B)	<p>As of Apr-2018, Mirrorbit Master and Mirrorbit Slave mode are not supported.</p>

2.2. Establishing Communication with Instrumentation and Computers

The settings on the **Baud Rate** tab are the communications settings between the radio and the instrument or computer it is connected to (radio serial port to the device).

Important! These settings are unique to each radio, and do not need to match across the network.

Example: A pair of radios may be used in an application to send data from remote process instrumentation to an engineer's computer. In this application, the **Baud Rate** for the radio on the instrumentation might be set to 9600 and the radio on the polling host might be set to 57,600.

These settings are available in the **Baud Rate** menu in the terminal interface, and apply to both Point-to-Point and Point-to-MultiPoint networks.

Note: See the [Parameter Preference](#) for a description of the parameter table's content.

2.2.1. Baud Rate

Baud Rate	
Setting	Description
Default Setting	115200
Options	600, 1200, 2400, 4800, 9600, 19200, 38400, 57600, 76800, 115200, 230400
Terminal Menu	(1) Set Baud Rate
Description:	<ul style="list-style-type: none"> This is the communication rate between the radio's data port and the instrument it is connected to. This setting is independent from the baud rate for the other radios in the network. <p>Note: With a poor RF link, this may actually result in slower data communications.</p> <ul style="list-style-type: none"> The Setup Port Baud Rate always defaults to 19,200 no matter how the Data Port Baud Rate is set. <ul style="list-style-type: none"> The only exception is Mode 6. <ul style="list-style-type: none"> For more information, see Application Note #5476, Mode 6. <p>FREEWAVE Recommends: With a Baud Rate setting of 38,400 or higher, FreeWave recommends using the lines of the Flow Control (on page 39).</p>

2.2.2. Data Parity

Data Parity																													
Setting	Description																												
Default Setting	0 (8, N, 1)																												
Options	See Description.																												
Terminal Menu	(1) Set Baud Rate > (A) Data Parity																												
Description:	<ul style="list-style-type: none"> Six data word length and parity configurations are available for use with FreeWave radios. The default setting is 8-None-1 and is the most commonly used serial communications protocol. <p>This table describes each option:</p> <table border="1"> <thead> <tr> <th>Option</th> <th>Data Bits</th> <th>Parity</th> <th>Stop Bits</th> </tr> </thead> <tbody> <tr> <td>0</td> <td>8</td> <td>None</td> <td>1</td> </tr> <tr> <td>1</td> <td>7</td> <td>Even</td> <td>1</td> </tr> <tr> <td>2</td> <td>7</td> <td>Odd</td> <td>1</td> </tr> <tr> <td>3</td> <td>8</td> <td>None</td> <td>2</td> </tr> <tr> <td>4</td> <td>8</td> <td>Even</td> <td>1</td> </tr> <tr> <td>5</td> <td>8</td> <td>Odd</td> <td>1</td> </tr> </tbody> </table>	Option	Data Bits	Parity	Stop Bits	0	8	None	1	1	7	Even	1	2	7	Odd	1	3	8	None	2	4	8	Even	1	5	8	Odd	1
Option	Data Bits	Parity	Stop Bits																										
0	8	None	1																										
1	7	Even	1																										
2	7	Odd	1																										
3	8	None	2																										
4	8	Even	1																										
5	8	Odd	1																										

2.2.3. Flow Control

Flow Control	
Setting	Description
Default Setting	(0) None
Options	<ul style="list-style-type: none"> (0) None - No flow control CTS is active and de-asserts when buffering is 98% full. Can pass XON/XOFF data but does not use it in any way. (1) RTS - Uses RTS/CTS (Request to Send/Clear to Send) for flow control. <ul style="list-style-type: none"> CTS performs the same way as in option (0) None. RTS must be activated for the radio to output data over the serial port. (2) DTR - Uses DTR/DSR (Data Terminal Ready/Data Set Ready) for flow control. (3) DOT - Half Duplex.
Terminal Menu	(1) Set Baud Rate > (F) FlowControl

2. Basic Radio Programming and Setup

MM3-T
User & Reference Manual

Flow Control	
Setting	Description
Description:	<p>Specifies the hardware flow control for the data port on the radio.</p> <p>Flow control is the process of managing the speed data is transmitted to not overwhelm the device receiving the transmission.</p> <div style="border: 1px solid gray; padding: 5px; margin-top: 10px;"> <p>FREEWAVE Recommends: Use Flow Control if the Baud Rate is higher than 38,400.</p> </div>

2.2.4. Modbus RTU

Note: When using the radio in **Modbus RTU** mode, the **Master Packet Repeat** parameter setting on the **MultiPoint Parameters** tab MUST match in every radio.

Modbus RTU	
Setting	Description
Default Setting	0 (Disabled)
Options	0 to 9
Terminal Menu	(1) Set Baud Rate > (B) Modbus RTU
Description:	<p>A setting other than 0 in this parameter causes the radio to wait for an amount of time gathering data before sending out the RF link.</p> <ul style="list-style-type: none"> • 0 (Disabled) - The radio sends data out through its RF link as soon as the data is received into the serial port. This is the default setting. • 1 - The radio waits for a number of slots equal to two times the Master Packet Repeat setting before sending the received data out the RF link. <div style="border: 1px solid gray; padding: 5px; margin-top: 10px;"> <p>Example: If the Master Packet Repeat parameter is set to 3, the radio waits for 6 slots, gathering data up the whole time. At the end of the 6 slots, the radio sends all received data in one “burst.” This is the appropriate setting for most Modbus RTU devices.</p> </div> <ul style="list-style-type: none"> • 2 or higher - The radio waits for a number of slots calculated using this formula: $(\text{Modbus RTU setting} + \text{Master Packet Repeat setting} + 1) \times 2$ <div style="border: 1px solid gray; padding: 5px; margin-top: 10px;"> <p>Example: In a radio where the Modbus RTU setting is 2 and the Master Packet Repeat setting is 3, the radio waits for $(2 + 3 + 1) \times 2$, or 12 slots.</p> </div>

2.2.5. Serial Interface

Serial Interface	
Setting	Description
Default Setting	(0) RS232
Options	
Terminal Menu	(1) Set Baud Rate > (C) RS232/485
Description:	Use this option to set the protocol of the data port for connection to an external device. <div style="border: 1px solid black; padding: 5px; margin: 5px 0;"> <p>Note: This setting must be 0 in TTL RF board products.</p> </div>

2.2.6. Setup Port

Important! Do NOT change this setting unless the correct programming cable is available for the new setting.

Setup Port	
Setting	Description
Default Setting	(3) Both
Options	<ul style="list-style-type: none"> • (1) Main Only - Programming and reading a radio's setup information is done through the data port. • (2) Diagnostics Only - Programming and reading a radio's setup information is done through the diagnostic port. • (3) Both - Programming and reading a radio's setup information is done through either the data port or the diagnostic port .
Terminal Menu	(1) Set Baud Rate > (D) Setup Port
Description:	Determines which port on the radio, Main or Diagnostics, is used to access the parameter settings in Tool Suite or enter the Setup main menu in the terminal interface.

2.2.7. Turn Off Delay

Note: This setting is not supported in the MM3-T radios.

2.2.8. Turn On Delay

Note: This setting is not supported in the MM3-T radios.

2.2.9. Use Break to Access Setup

Note: This setting is typically only used in OEM scenarios.

Use Break to Access Setup	
Setting	Description
Default Setting	Disabled
Options	<ul style="list-style-type: none">• (0) - Disabled - The break command is disabled.• (1) - Enabled - The Setup menu is sent at 19,200 bps.• (2) - Enabled - The Setup menu is sent at the radio's current baud rate.
Terminal Menu	(1) Set Baud Rate > (G) Use break to access setup
Description:	<p>Enables a break command to put the radio into Setup mode over the data port. To send a break character, the end device must hold the Tx data line in the space voltage level for longer than 1 character time.</p> <div data-bbox="487 819 1364 987" style="border: 1px solid gray; padding: 5px;"><p>Example: If a character is defined as having 1 start bit, 8 data bits, and 1 stop bit, the character time is 10 bits. Thus, the transmit data line must be held in the space voltage level for a period of time longer than 10 bits.</p></div>

2.3. Establishing Communication with Other Radios in the Network

For the radios in the network to communicate successfully, the radios need to be told what other devices are available for them to communicate with. Use one of these options:

- **Network ID** - Used in MultiPoint Networks, the **Network ID** parameter is available on the **MultiPoint Parameters** tab.
 - Each radio in a single network should be assigned the same ID.
 - A Slave links with the first Master or Repeater that it hears that has a matching **Network ID**.
 - Because the **Network ID** does not use serial numbers, MultiPoint Masters and Repeaters may be replaced without reprogramming all of the Slaves in the network. The **Network ID** function should be used in conjunction with the **Subnet ID** feature (if necessary) to route data through the radio network.
 - Without having the serial numbers in the Call Book, Slaves may establish communications with different Masters that match the radio's golden settings described below, though not at the same time. This is very useful in mobile MultiPoint applications.
 - For information about setting the **Network ID** parameter in a MultiPoint Network, see [Using the Network ID in MultiPoint Networks \(on page 68\)](#).
- **Call Book** - The Call Book is **required** in Point-to-Point networks.
 - The Call Book stores serial numbers of other radios in the network that are allowed to talk to a radio.
 - Using the Call Book offers both security and flexibility in determining how FreeWave radios communicate with each other.

FREEWAVE Recommends: While the Call Book is an option in Point-to-MultiPoint networks, FreeWave **strongly recommends** using the **Network ID** feature in most applications. If a large MultiPoint network is implemented using the Call Book and a radio needs to be added to or replaced in the network, each radio in the network must be physically reprogrammed and the new serial number entered in the radio's Call Book. This can be a time consuming process and can cause a delay in getting the network back up and running. Because the **Network ID** does not use serial numbers, MultiPoint Master radios and Repeaters may be added or replaced without reprogramming each Slave radio in the network.

Note: For more information about defining the Call Book in a Point-to-Point network, see [Using the Call Book in Point-to-Point Networks \(on page 90\)](#).

2.3.1. Golden Settings

A standard network requires that these parameters are set the same on all radios in the network. FreeWave refers to these as the **Golden Settings**:

- Frequency Key
- Min Packet Size
- Max Packet Size
- Network ID
- RF Data Rate

Radios that contain the same settings in all these parameters can communicate with each other.

- If using the Call Book instead of the **Network ID**, or are running a Point-to-Point network, the appropriate serial numbers must be listed in the Call Book for each radio.
- If working with parallel Repeaters, the **Frequency Key** setting may differ.

2.4. Designate the RF Transmission Characteristics

The **Transmission Characteristics** parameters are used to change settings that determine how data is sent between radios in the network. Many of these parameters must be maintained throughout the network for proper functionality.

Important! The parameters on the **Transmission Characteristics** tab are only for the advanced user who has a good understanding of the principles of RF transmission.

Several settings on a Slave or Repeater radio come from the Master, and are therefore set **only** at the Master. Settings that you must set on each **Slave or Repeater** include:

- Hop Table Offset
- Hop Table Size
- Hop Table Version
- Retry Time Out
- Slave Security
- Transmit Power

Accept the default settings on the **Transmission Characteristics** tab when completing basic setup.

However, these parameters must be set and they **must be the same** for all radios in the network:

- Frequency Key
- Hop Table properties (Size, Version, and Offset)
- Max Packet Size
- Min Packet Size
- RF Data Rate

Set these parameters on the **Transmission Characteristics** tab. These settings are available in the **Edit > Radio Transmission Characteristics** menu in the terminal interface and apply to

both Point-to-Point and Point-to-MultiPoint networks, unless indicated otherwise in the description.

Note: See the [Parameter Preference](#) for a description of the parameter table's content.

2.4.1. 900MHz Channel Select Parameters

- The Channel tables are used to enable / disable each channel within the range of channels available in the user's region.
 - The available frequencies are shown as either Enabled (**1**) or Disabled (**0** (zero)) in the CLI.
- Specific regional frequencies are set by FreeWave.
 - These frequencies are NOT available to customers.
 - They are represented in the CLI by a . (period).

900MHz Channel Select Parameters	
Setting	Description
Default Setting	(0) Mode Set = Zone
Options	(0) Mode Set (1) Set Single Channel Mask
Terminal Menu	(3) Edit Radio Transmission Characteristics > (0) FreqKey > F > (4) <div style="border: 1px solid black; padding: 5px;"> <p>Important! This command is NOT visible in the CLI menu. Type 4 and press <Enter> to view the Channel Select Parameters. See Access to the Single Channel Mask (on page 47).</p> </div>

900MHz Channel Select Parameters	
Setting	Description
Description:	<p>(0) Mode Set options</p> <ul style="list-style-type: none"> • 0 - sets as Single mode • 1 - sets as Zone mode that allows the 900MHz Frequency Zones (on page 49) to be changed. <p>(1) Set Single Channel Mask</p> <div style="border: 1px solid black; padding: 5px; margin: 10px 0;"> <p>Important! This option is ONLY available if Single is selected in the Mode Set command.</p> </div> <ol style="list-style-type: none"> 1. Enter 1 and press <Enter>. 2. Enter the Channel ID (from 0 to 111) and press <Enter>. 3. Enter 1 to set the channel On or Enter 0 (zero) to turn the channel Off. <div style="background-color: #e0e0e0; padding: 5px; margin: 10px 0;"> <p>Example: See Example of Single Channel Mask (on page 48).</p> </div> <div style="border: 1px solid black; padding: 5px; margin: 10px 0;"> <p>Note: See 900MHz Channel Frequency IDs (on page 133) or 900MHz Channel Frequency IDs - China for the Channel IDs to use.</p> </div>

Access to the Single Channel Mask

```

MAIN MENU
D2 AES Version v
902 - 928 MHz
Modem Serial Number 990-1374
Model Code DMM2T

(0) Set Operation Mode
(1) Set Baud Rate
(2) Edit Call Book
(3) Edit Radio Transmission Characteristics
(4) Show Radio Statistics
(5) Edit MultiPoint Parameters
(6) TDMA Menu
(8) Chg Password
(Esc) Exit Setup

Enter Choice

RADIO PARAMETERS

WARNING: Do not change parameters without reading manual

(0) FreqKey 5
(1) Max Packet Size 8
(2) Min Packet Size 9
(3) Xmit Rate 1
(4) RF Data Rate 3
(5) RF Xmit Power 10
(6) Slave Security 0
(7) RTS to CTS 0
(8) Retry Time Out 255
(9) Lowpower Mode 0
(A) High Noise 0
(B) MCU Speed 0
(C) RremoteLED 0
(D)
(E)
(Esc) Exit to Main Menu

Enter Choice 0
Enter New Frequency Key (0-E) <F for more>f
Hop Table Parameters

(0) Hop Table Version 0
(1) Hop Table Size 112
(2) Hop Freq Offset 0
(3) Frequency Zone 1111111111111111
(Esc) Exit to Radio Menu

Enter Choice 4 } Hidden Option 4

CHANNEL SELECT PARAMETERS

NOTE: See manual for Frequency to Channel ID translation!
Customer Channel Mask IDs [1 = on] [0 = off] [. = unavailable/off]

ID 0-----7 8-----15 16-----23 24-----31 32-----39 40-----47 48-----55
11111111 ..... 11111111 11110000 00001111 11111111 1111.....

ID 56-----63 64-----71 72-----79 80-----87 88-----95 96-----103 104-----111
....1111 11111111 11110000 00001111 11111111 ..... 11111111

Min Possible Channels = 50
Total Channels selected = 72

(0) Mode Set Single
(1) Set Single Channel Mask
(Esc) Exit to Hop Table Menu

Enter Choice

```

Figure 20: Access to Single Channel Mask

2. Basic Radio Programming and Setup

MM3-T User & Reference Manual

Example of Single Channel Mask

```

CHANNEL SELECT PARAMETERS
NOTE: See manual for Frequency to Channel ID translation!
Customer Channel Mask IDs [1 = on] [0 = off] [.] = unavailable/off]
ID 0-----7 8-----15 16-----23 24-----31 32-----39 40-----47 48-----55
11111111 ..... 11111111 11110000 00001111 11111111 1111.....
ID 56-----63 64-----71 72-----79 80-----87 88-----95 96-----103 104-----111
.....1111 11111111 11110000 00001111 11111111 ..... 11111111

<0> Mode Set      Single
<1> Set Single Channel Mask
<Esc> Exit to Hop Table Menu

Enter Choice 1
Enter Channel ID <0-111> 34
Enter 1 to set Channel on, 0 to turn off. 1
Channel 34 On

CHANNEL SELECT PARAMETERS
NOTE: See manual for Frequency to Channel ID translation!
Customer Channel Mask IDs [1 = on] [0 = off] [.] = unavailable/off]
ID 0-----7 8-----15 16-----23 24-----31 32-----39 40-----47 48-----55
11111111 ..... 11111111 11110000 00011111 11111111 1111.....
ID 56-----63 64-----71 72-----79 80-----87 88-----95 96-----103 104-----111
.....1111 11111111 11110000 00001111 11111111 ..... 11111111

<0> Mode Set      Single
<1> Set Single Channel Mask
<Esc> Exit to Hop Table Menu

Enter Choice 1
Enter Channel ID <0-111> 34
Enter 1 to set Channel on, 0 to turn off. 0
Channel 34 Off

CHANNEL SELECT PARAMETERS
NOTE: See manual for Frequency to Frequency to Channel ID translation!
Customer Channel Mask IDs [1 = on] [0 = off] [.] = unavailable/off]
ID 0-----7 8-----15 16-----23 24-----31 32-----39 40-----47 48-----55
11111111 ..... 11111111 11110000 00001111 11111111 1111.....
ID 56-----63 64-----71 72-----79 80-----87 88-----95 96-----103 104-----111
.....1111 11111111 11110000 00001111 11111111 ..... 11111111

<0> Mode Set      Single
<1> Set Single Channel Mask
<Esc> Exit to Hop Table Menu

Enter Choice

```

In this example, FreeWave has blocked these frequencies.
They CANNOT be changed or used by customers.

1. Frequencies: 904.0896 through 905.7024 (Channel IDs 8 to 15)
2. Frequencies: 914.2272 through 915.8400 (Channel IDs 52 to 59)
3. Frequencies: 924.3648 through 925.9776 (Channel IDs 96 to 103)

These frequencies have been deactivated by the user:

4. Frequencies: 908.6976 through 910.3104 (Channel IDs 28 to 35)
5. Frequencies: 919.7568 through 921.3696 (Channel IDs 76 to 83)

This shows how the user turns **ON** Frequency 910.0800 (Channel ID 34).

This shows how the user turns **OFF** Frequency 910.0800 (Channel ID 34).

Figure 21: Example of Single Channel Mask

2.4.2. 900MHz Frequency Key (Golden Setting)

Note: In MultiPoint networks, the **Frequency Key** must be set identically in all radios. Any radio with a **Frequency Key** different from the Master radio will not establish a link. In Point-to-Point networks the Master radio's settings take precedence over the Slave radio. There are exceptions if the network contains parallel repeaters. For more information, see [Working with Parallel Repeaters on page 95](#).

900MHz Frequency Key (Golden Setting)

Setting	Description
Default Setting	5

900MHz Frequency Key (Golden Setting)	
Setting	Description
Options	0 to 9 A to E <div style="border: 1px solid black; padding: 5px; margin-top: 10px;"> <p>Important! Do NOT use Frequency Key E with the 915 to 928 MHz, 916 to 920 MHz, and 921 to 928 MHz hop tables.</p> </div>
Terminal Menu	(3) Edit Radio Transmission Characteristics > (0) FreqKey
Description:	<ul style="list-style-type: none"> Fifteen choices are available for the Frequency Key (0 to 9 and A to E) setting, representing 15 different pseudo-random hop patterns. Hopping patterns minimize the interference with other FreeWave radios operating in the area. <div style="background-color: #e0e0e0; padding: 10px; margin-top: 10px;"> <p>Example: If 10 pairs of FreeWave radios are operating on different networks in close proximity, setting a different Frequency Key value reduces the chance that radios hop to the same frequency at the same time. If two networks were to hop to the same frequency, the next hop would be to a different frequency for both networks.</p> </div> <div style="border: 1px solid black; padding: 5px; margin-top: 10px;"> <p> Tip Gain additional network separation by adjusting the Max Packet Size and Min Packet Size parameters.</p> </div> <div style="border: 1px solid black; padding: 5px; margin-top: 10px;"> <p>Note: Use the Hop Table Version, Hop Table Size, and Frequency Zone parameters to define more network differentiation by limiting the number and location of frequencies the radios may hop in the 902 to 928 MHz band.</p> </div> <div style="border: 1px solid black; padding: 5px; margin-top: 10px;"> <p>Important! 900MHz radios do NOT use the Hop Frequency Offset setting.</p> </div>

2.4.3. 900MHz Frequency Zones

Note: In MultiPoint networks, this setting needs to only be set on the Master. In a Point-to-Point network, the Master and the Slave must have matching **Frequency Zone** settings.

Important! **Frequency Zones** are NOT valid if **Single** is selected in the [900MHz Channel Select Parameters \(on page 45\)](#).

900MHz Frequency Zones	
Setting	Description
Default Setting	All zones selected
Options	See Description.
Terminal Menu	(3) Edit Radio Transmission Characteristics > (0) FreqKey > F > (3) Frequency Zone
Description:	<p>Divides the available band (902 MHz to 928 MHz) into smaller bands. In this case 16 smaller bands each consisting of 5, 7, and 8 frequency channels depending on the frequency zone.</p> <ul style="list-style-type: none"> • These 16 zones are stored in a binary word, which is made up of 16 bits numbered 0 to 15. • Displayed in LSB to MSB, these bits directly represent the zones that the radio operates on from lowest frequency to highest. • A value of 1 in the bit sequence instructs the radio to operate within the represented band. • A value of 0 bypasses the represented band. This feature should only be used with the standard hop table. <div style="border: 1px solid black; padding: 5px; margin: 10px 0;"> <p>Caution: Set the Hop Table Version to 902 to 928 MHz when using Frequency Zones.  If another Hop Table Version is selected, the limitations of that selection are also applied to the hopping pattern.</p> </div> <div style="border: 1px solid black; padding: 5px; margin: 10px 0;"> <p>Example: If 916 to 920 is used as the Hop Table Version, only the middle of the band is available in the pattern. Then, if Frequency Zones 5, 6, 7, 8, and 9 are set to 0, no allowable frequencies are available for the radio to use.</p> </div>

900MHz Frequency Zones Table



Warning! FCC and IC regulations require a minimum of 50 separate channels be used within a hop pattern.

Use the 900MHz **Frequency Zones Table** to determine the number of frequency zones required for legal FCC use.

Example: Using zones 1 to 7 is equal to 49 channels; this is NOT legal according to the FCC. Using zones 0 to 6 is equal to 50 channels; this is legal according to the FCC.

900MHz Frequency Zones			
Binary Zone Number (LSB First)	Beginning Freq. (MHz)	Ending Freq. (MHz)	Number Of Channels
1	902.2464	903.8592	8
2	904.0896	905.4720	7
3	905.7024	907.0848	7
4	907.3152	908.6976	7
5	908.9280	910.3104	7
6	910.5408	911.9232	7
7	912.1536	913.5360	7
8	913.7664	915.1488	7
9	915.3792	916.7616	7
10	916.9920	918.6048	8
11	918.8352	920.2176	7
12	920.4480	921.8304	7
13	922.0608	923.4432	7
14	923.6736	925.0560	7
15	925.2864	926.6688	7
16	926.8992	927.8208	5

Enable Frequency Zones in Tool Suite

1. In the Tool Suite Configuration application, select the device to program.
2. Click the **(3) Transmission Characteristics** tab.
3. Click **Frequency Zones** to view the available frequency zones.
4. Select the **Frequency Zones** to enable.

Enable Frequency Zones using the Terminal Interface

1. On the main **Setup** menu, select **3 Edit Radio Transmission Characteristics**.
2. Select option **0 FreqKey**.
3. Select **F** for **More**.
4. Select option **3 Frequency Zone**.
5. Enter:
 - 1** to enable a frequency zone or
 - 0** to disable a frequency zone.

Note: **Frequency Zone** entries begin with **0** (LSB) and continue through **15** (MSB).

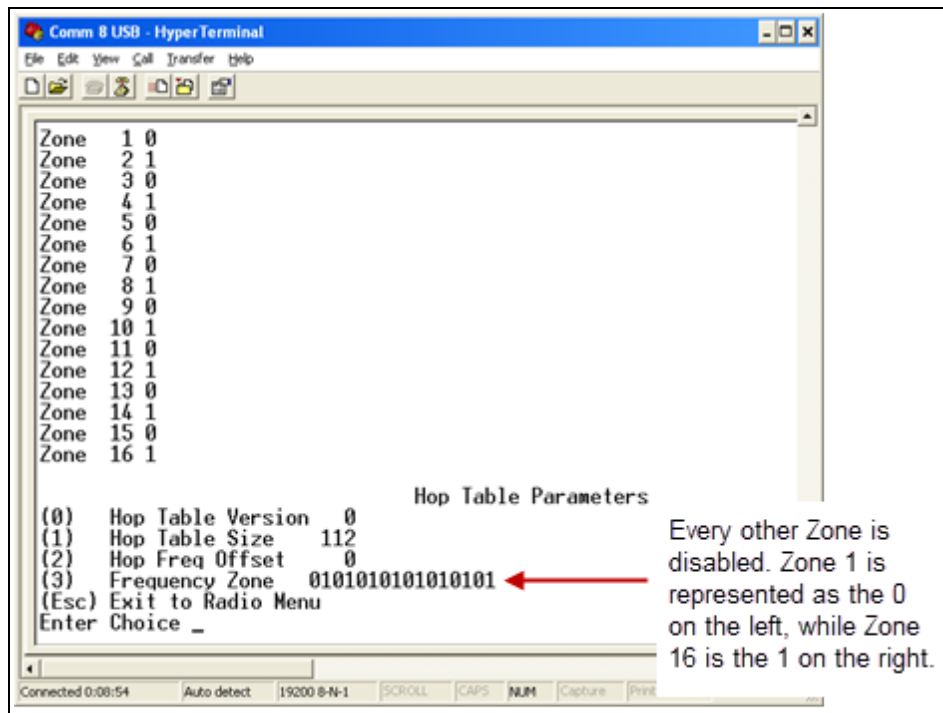

Figure 22: HyperTerminal window with Frequency Zones

2.4.5. 900MHz Hop Table Size

Note: All radios in a network must have identical **Hop Table** settings.



Warning! FCC and IC regulations require a minimum of 50 separate frequency channels be used within a hop pattern.

900MHz Hop Table Size	
Setting	Description
Default Setting	112
Options	50 to 111
Terminal Menu	(3) Edit Radio Transmission Characteristics > (0) FreqKey > F > (1) Hop Table Size

900MHz Hop Table Size	
Setting	Description
Description:	<p>Defines how many separate channels a given network uses.</p> <div style="border: 1px solid black; padding: 5px; margin-top: 10px;"> <p>FREEWAVE Recommends: Use the Frequency Zones instead of the Hop Table Size setting.</p> </div>

2.4.6. 900MHz Hop Table Version

Note: All radios in a network must have identical **Hop Table** settings.

900MHz Hop Table Version	
Setting	Description
Default Setting	902-928 MHz
Options	<ul style="list-style-type: none"> • 902-928 MHz, full band • 915-928 MHz • 903.744-926.3232 MHz • 916-920 MHz • 921-928 MHz • 902-911_919-928 MHz <ul style="list-style-type: none"> • Uses 902-928 MHz with center frequencies of 911-919 MHz notched out. • 902-915 MHz <div style="border: 1px solid black; padding: 5px; margin-top: 10px;"> <p>Important! If using a Hop Table Version setting of 915-928 MHz, 916-920 MHz, or 921-928 MHz, do NOT set the Frequency Key parameter setting to E (916-920 MHz).</p> </div>
Terminal Menu	(3) Edit Radio Transmission Characteristics > (0) FreqKey > F > (0) Hop Table Version

900MHz Hop Table Version																	
Setting	Description																
Description:	<p>Determines the section of the 900 MHz band the radio uses.</p> <p>In the terminal interface, enter the number that corresponds to the frequency band:</p> <table border="1"> <thead> <tr> <th>Terminal Interface Number</th> <th>Frequency Band</th> </tr> </thead> <tbody> <tr> <td>0</td> <td>902-928 MHz, uses the full band</td> </tr> <tr> <td>1</td> <td>915-928 MHz</td> </tr> <tr> <td>2</td> <td>903.744-926.3232 MHz</td> </tr> <tr> <td>3</td> <td>916-920 MHz</td> </tr> <tr> <td>4</td> <td>921-928 MHz</td> </tr> <tr> <td>5</td> <td>902-911_919.928 MHz Uses 902-928 MHz with center frequencies of 911-919 MHz notched out.</td> </tr> <tr> <td>6</td> <td>902-915 MHz</td> </tr> </tbody> </table>	Terminal Interface Number	Frequency Band	0	902-928 MHz, uses the full band	1	915-928 MHz	2	903.744-926.3232 MHz	3	916-920 MHz	4	921-928 MHz	5	902-911_919.928 MHz Uses 902-928 MHz with center frequencies of 911-919 MHz notched out.	6	902-915 MHz
Terminal Interface Number	Frequency Band																
0	902-928 MHz, uses the full band																
1	915-928 MHz																
2	903.744-926.3232 MHz																
3	916-920 MHz																
4	921-928 MHz																
5	902-911_919.928 MHz Uses 902-928 MHz with center frequencies of 911-919 MHz notched out.																
6	902-915 MHz																

2.4.7. Max Packet Size and Min Packet Size (Golden Setting)

Note: In MultiPoint networks, the **Max Packet Size** and **Min Packet Size** must be set identically in all radios.
In Point-to-Point networks the Master radio's settings take precedence over the Slave radio.

Max Packet Size and Min Packet Size (Golden Setting)	
Setting	Description
Default Setting	<ul style="list-style-type: none"> Max Packet Size = 8 Min Packet Size = 9
Options	Any number between 0 and 9.
Terminal Menu	(3) Edit Transmission Characteristics > (1) Max Packet Size and (2) Min Packet Size

Max Packet Size and Min Packet Size (Golden Setting)	
Setting	Description
Description:	<p>The Max and Min Packet Size parameter settings and the RF Data Rate parameter determine the number of bytes in the packets.</p> <ul style="list-style-type: none"> Throughput can be enhanced when packet sizes are optimized. In Point-to-Point mode, the Max and Min Packet Size settings do not have material impact on throughput unless 115.2 kbps is desired. However, this may have an impact on latency. <div style="border: 1px solid gray; padding: 5px; margin: 10px 0;"> <p>Example: If small amounts of data are sent and large packet sizes are selected, a certain amount of time wasted between each packet would be seen.</p> </div> <ul style="list-style-type: none"> In each over-the-air frame, both the Master and Slave are guaranteed the number of bytes specified in the Minimum Packet Size parameter. In the Master, this is used for maintaining the RF link whether the Gateway has data to transmit or not. The Maximum Packet Size parameter is used to allocate the maximum number of bytes for each Master transmission. The Minimum Packet Size parameter is used to allocate the minimum number of bytes for each Slave transmission. If the Master does not use all the bytes allocated in the Maximum Packet Size setting minus the Minimum Packet Size setting, then the remaining bytes are available for the Slave.

2.4.8. MCU Speed

MCU Speed	
Setting	Description
Default Setting	(0) Normal
Options	<ul style="list-style-type: none"> (0) Normal (low speed) - Reduces current consumption. (1) Fast (high speed) - Required for 230 KBaud and greater data port rate. <div style="border: 1px solid gray; padding: 5px; margin: 10px 0;"> <p>Note: If the radio is AES enabled and using the encryption functionality, set this parameter to 3 using the terminal interface. The value is accepted even though it is not viewable as an option and applies only when using AES encryption. For more information about setting up AES encryption, see Enable and Set Up AES Encryption (on page 98).</p> </div>
Terminal Menu	(3) Edit Radio Transmission Characteristics > (B) MCU Speed
Description:	Controls the speed of the Micro Controller Unit (MCU) in the radio.

2.4.9. Remote LED

Note: This setting is not supported in the MM3-T radios.

2.4.10. Retry Time Out

Retry Time Out	
Setting	Description
Default Setting	255
Options	<p>Any number between 0 and 255 in MultiPoint networks.</p> <div style="border: 1px solid black; padding: 5px; margin: 5px 0;"> <p>Note: The minimum in 900MHz radios is 8 seconds.</p> </div> <p>Any number between 151 and 255 in Point-to-Point networks.</p>
Terminal Menu	(3) Edit Transmission Characteristics > (8) Retry Time Out
Description:	<p>The Retry Time Out parameter in a Slave or Repeater sets the delay the unit waits before dropping the connection to a Master or Repeater.</p> <ul style="list-style-type: none"> The factory default is set at the maximum of 255. <ul style="list-style-type: none"> With a setting of 255, the Master allows a Slave or Repeater to stay connected as long as 1 packet in 255 is successfully received at the Master. The maximum setting means that if 1 packet in 255 is sent successfully from the Master to the Slave or Repeater, the link is maintained. This allows a Slave or Repeater to drop a connection if less than 1 in 8 consecutive packets is successfully received from the Master. <p>The Retry Time Out parameter is useful when a MultiPoint network has a roving Master or Slave. As the link gets weaker, a lower setting allows a poor link to break in search of a stronger one.</p> <div style="border: 1px solid black; padding: 5px; margin: 5px 0;"> <p>FREEWAVE Recommends: Setting the Retry Time Out parameter to 20 in the MultiPoint Master is recommended in areas where several FreeWave networks exist.</p> <p>This recommended setting allows Slaves and Repeaters to drop the connection if the link becomes too weak, while at the same time prevent errant disconnects due to interference from neighboring networks.</p> </div> <div style="border: 1px solid black; padding: 5px; margin: 5px 0;"> <p>Note: While intended primarily for MultiPoint networks, the Retry Time Out parameter may be changed in Point-to-Point networks. However, the value in Point-to-Point mode should NOT be set to less than 151.</p> </div>

2.4.11. RF Data Rate (Golden Setting)

Note: In MultiPoint networks, the **RF Data Rate** parameter must be set the same in all radios. Any radio with an **RF Data Rate** setting different from the Master will not establish a link. In Point-to-Point networks the Master setting takes precedence over the Slave.

RF Data Rate (Golden Setting)	
Setting	Description
Default Setting	(3) Normal
Options	<ul style="list-style-type: none"> (2) High - 153.6 kbps (3) Normal - 115.2 kbps
Terminal Menu	(3) Edit Transmission Characteristics > (4) RF Data Rate
Description:	<div style="border: 1px solid black; padding: 5px; margin-bottom: 10px;"> <p>Important!: Do NOT confuse the RF Data Rate with the serial port Baud Rate.</p> </div> <p>FreeWave radios have these RF Data Rate settings:</p> <ul style="list-style-type: none"> 2 (High). <ul style="list-style-type: none"> Use setting 2 (RF Speed of 153.6 kbps) when the radios are close together and need to optimize data throughput. 3 (Normal). <ul style="list-style-type: none"> Use setting 3 (RF Speed of 115.2 kbps) when the radios are farther away and a solid data link is preferred over data throughput.

2.4.12. RTS to CTS

Important!:
It is NOT recommended to enable this feature when operating at Baud Rates above 38,400.

RTS to CTS	
Setting	Description
Default Setting	(0) Disabled
Options	<ul style="list-style-type: none"> (0) Disabled (1) Enabled (2) Line Alarm <div style="border: 1px solid black; padding: 5px; margin-top: 10px;"> <p>Note: Setting 2 is described in detail in the Application Note #5437, DTR to CTS Line Alarm Feature.</p> </div>
Terminal Menu	(3) Edit Transmission Characteristics > (7) RTS to CTS

RTS to CTS	
Setting	Description
Description:	<p>Use this option to set the RTS line on the Master radio to control the CTS line of the Slave.</p> <p>With RTS to CTS enabled:</p> <ul style="list-style-type: none"> • In MultiPoint networks, the Master RTS line controls all Slave's CTS lines. • The CTS line stops functioning as flow control. • The Master senses the RTS line prior to all scheduled packet transmissions. <ul style="list-style-type: none"> • If the state has changed, the Master then transmits a message to the Slave with the new status. This transmission occurs regardless of data being sent. • If data is ready to be sent, the RTS status message is sent in addition to the data. • In Point-to-Point mode, the Master continues sending the new status message until it receives an acknowledgment from the Slave. • In MultiPoint mode, the Master repeats the message the number of times equal to the Master Packet Repeat value in the MultiPoint Parameters tab. • Master transmit times are completely asynchronous to the occurrence of any change of the RTS line; the latency time from RTS to CTS is variable. • The Max and Min Packet Size parameters determine this duration. <ul style="list-style-type: none"> • Setting both parameters to their maximum value of 9 produces a maximum latency time of approximately 21ms, given no Repeaters in the network. • At the minimum settings for Max and Min Packet Size (0), the time is approximately 5.9ms. • This latency can increase significantly if packets are lost between the Master and Slave. • In Point-to-MultiPoint mode, no absolute guarantee is made that the state change is communicated to all Slaves. • In MultiPoint networks with Repeaters present, the latency is cumulative for each serial Repeater. <p>Example: If the latency between the Master and the first Repeater is 15ms, and two serial Repeaters are present, the total latency is 45ms. (M—R1 (15ms) + R1—R2 (15ms) + R2—S (15ms) = 45ms).</p> <p>Important! The RTS to CTS feature does NOT function in Point-to-Point networks that contain a Repeater. If this feature is needed in such network, the mode should be changed to Point-to-MultiPoint.</p> <ul style="list-style-type: none"> • If DTR Connect on the Tool Suite MultiPoint Parameters tab is enabled and set to 2, the RTS to CTS feature does not work.

RTS to CTS	
Setting	Description
	<ul style="list-style-type: none"> If DTR Connect is enabled and set to 1, RTS to CTS mode takes precedence over the functionality of the CTS line on the Slave relating to the DTR Connect feature.

2.4.13. Slave Security

Note: The **Slave Security** parameter has no effect in Point-to-MultiPoint networks where the **Network ID** is used.

Slave Security	
Setting	Description
Default Setting	(0) On
Options	(0) On (1) Off
Terminal Menu	(3) Edit Transmission Characteristics > (6) Slave Security
Description:	<ul style="list-style-type: none"> Slave Security allows Slave radios to accept transmissions from a Master not included in the Call Book. <ul style="list-style-type: none"> The default setting of 0 (On) means only Masters in the Slave radio's Call Book may link to that Slave. The Slave Security parameter may be disabled (setting of 1) allowing any Master to call the Slave. The Slave Security parameter must be set to 1 when the unit is operating in Mode 6, Slave/Master Switchable or a Point-to-Point network where the Slave may need to accept calls from more than 10 different Masters. <ul style="list-style-type: none"> See Application Note #5476: Mode 6 for additional information. When the Slave Security parameter is set to 1, the radio accepts calls from any other radio. Additional network security measures may be taken to prevent unauthorized access (e.g., changing default settings for Frequency Key, Hop Table, or Frequency Zones).

2.4.14. Transmit Power

Transmit Power	
Setting	Description
Default Setting	10
Options	Any number between 0 and 10

2. Basic Radio Programming and Setup

MM3-T
User & Reference Manual

Transmit Power	
Setting	Description
Terminal Menu	(3) Edit Transmission Characteristics > (5) RF Xmit Power
Description:	<p>Sets the output power of the radio in dBm.</p> <ul style="list-style-type: none"> In MM3 radios, a setting of 10 is approximately 0.977 W (29.9dBm) of output power. <div style="border: 1px solid gray; padding: 5px; margin-top: 10px;">  <p>When testing radios, and they are in close proximity to one another, set the Transmit Power parameter to a low number. When deploying radios to the field, raise the Transmit Power number accordingly.</p> </div>

Important!: This table is for reference only. All Transmit Power settings below 9 are approximate.



Setting	Power (in mW) for MM3-T Radios
0	5
1	10
2	35
3	80
4	140
5	230
6	330
7	480
8	600
9	800
10	1000

 **Warning!** Before setting the TX power level, see section 2.52 in order to match the proper settings with the approved antenna selected. Improper settings and antenna configurations will result in non compliance of the FCC and ISED EIRP limits.

Mise en garde! Avant de régler le niveau de puissance d'émission, voir la section 2.52 afin de faire correspondre les paramètres appropriés avec l'antenne approuvée sélectionnée. Des réglages et des configurations d'antenne incorrects entraîneront la non-conformité aux limites de la FCC et d'ISDE PIRE.

2.4.15. Transmit Rate

Transmit Rate	
Setting	Description
Default Setting	(1) Normal
Options	<ul style="list-style-type: none"> 0 - Diagnostics 1 - Normal
Terminal Menu	(3) Edit Transmission Characteristics > (3) Xmit Rate

Transmit Rate	
Setting	Description
Description:	<p>MM3-T radios have two available Transmit Rate settings.</p> <ul style="list-style-type: none">The setting for normal operation of the radio is 1.When set to 0, the radios transmit back and forth continuously regardless if they have any actual data.0 should be used only as a diagnostic tool and not for normal operation.The strength of the signal may be gauged by the Clear to Send (CTS) LED.A solid red () CTS LED indicates a strong signal.A blinking () CTS LED indicates a weaker signal. <p>0 is useful to qualitatively gauge signal strength in Point-to-Point mode.</p>

2.5. About Antennas

FreeWave offers many antenna options. To improve the data link, FreeWave offers various antennas with cable lengths ranging from 13 inches up to 200 feet.

Consider the following antenna characteristics when choosing an antenna for your application:

- Antenna radiation patterns / antenna type
- Power gain
- Cable loss
- Directionality
- Polarization

When using antennas, follow the guidelines for selection, location, and installation provided in the sections below.

2.5.1 Antenna Location:

When using an external antenna, placement of the FreeWave transceiver's antenna is likely to have a significant impact on the transceiver's performance. The key to the overall robustness of the radio link is the height of the antenna. In general, FreeWave units with a higher antenna placement have a better communication link. However, a higher antenna may pick up more RF noise in the area, and other antennas in close proximity could cause interference. An adjustment as little as 2 feet in antenna placement can resolve some noise problems. In extreme cases, such as when interference is due to a pager or cellular tower, the band pass filters that FreeWave offers, may reduce this out-of-band noise.

Note: Use the Radio Statistics, available in option 4 in the main Setup menu of the radio to help identify problems.

Also consider the following points when locating antennas for your application:

2. Basic Radio Programming and Setup

MM3-T
User & Reference Manual

- Identify sites with “Line of Sight”. If you cannot see it you cannot talk to it.
- Long cable runs decrease signal and increase the amount of picked up noise. For example, if you use LMR 400 cable on a 200 foot tower, loss in the cable run alone is 8 dB over the 200 foot distance.

To help optimize your antenna location, have FreeWave complete a site study for you, free of charge. To initiate the request, complete and submit the Path Study form available from your sales representative. Email the completed form to pathstudy@freewave.com.

2.5.2 Approved Antennas for the 900 MHz MM3 Radio Family

Any antenna used with FreeWave transceivers must have the following characteristics to remain in compliance with FCC and ISED requirements and regulations.

- Antenna gain does not exceed 12 dBi for Yagi antennas and 8.15 dBi for Omni antennas.
- Set MM3 TX Power Level properly (see Section 2.4.14)

The complete list of antennas available from FreeWave, including antenna gains, is here:

900 MHz Antennas					MM3 TX Power Setting
Gain (dBd/dBi)	Manufacturer	Antenna Type	FreeWave Part Number for Ordering	Manufacturer Model Number	See Section 2.4.14
12 dBi	Wavelink	Yagi	EAN0906F	PRO890-12	5
6 dBd / 8.15 dBi	Antenex	Omni	EAN0906NF	FG9026	8
3 dBd / 5.15 dBi	Maxrad	Omni	EAN0900WC	MAX-9053	9
2.85 dBd / 5.0 dBi	Antenex Maxrd	Omni	EAN0905WC	EB8965C BMEFC8985HD	10
0.15dBd /2.3dBi	Mobile Mark	Omni	EAN0900SR	PSKN3-925S	10
-2.15 dBd/ 0 dBi	Mobile Mark	Omni	EAN0900SQ	PSTG0-915SE	10

2.5.3 Antenna Installation

Antennas must be professionally installed on a fixed, mounted, and permanent structure to satisfy RF exposure requirements.



Warning! Any antenna placed outdoors must be properly grounded. Use extreme caution when installing antennas and follow **all** manufacturer instructions included with the antenna.

Mise en garde ! Toute antenne placée à l'extérieur doit être correctement mise à la



terre. Soyez très prudent lors de l'installation d'antennes et suivre toutes les instructions du fabricant fournies avec l'antenne.

Per FCC and ISED regulations, any antenna used with FreeWave transceivers must be an approved antenna that has comparable performance parameters. For more information about approved antennas, see "[Approved Antennas for the 900 MHz MM3 Radio Family](#)" on page 2.5.2.

2.5.4 Cable Loss and Transmit Power Settings

The **Transmit Power** parameter is the output power of the transceiver. The transceiver output power level must be set to satisfy maximum Equivalent Isotropically Radiated Power (EIRP) requirements in the country in which the installation exists.

When setting up the network, consider the power gain that an antenna may add, and the power loss through cabling. Adjust the **Transmit Power** on the transceiver to ensure that you do not exceed the maximum EIRP for the regulating body where the installation exists. Use the tables below to determine the correct **Transmit Power** parameter setting for each transceiver in the network.

Important: The information in this section discusses FCC and ISED and ETSI maximum EIRP regulations. Ensure your installation meets the maximum EIRP requirements for the country in which you are installing transceivers. It remains the installer's responsibility to ensure that an installation is within EIRP emission limits.

The FCC and ISED permits 0.977 Watt output power at the transceiver. When calculating the power gain, use the following equation to determine the total output power at the antenna. Loss calculations should include cable, connectors, surge protectors, etc.

$$\text{Transceiver Output} - \text{Losses} + \text{Antenna Gain} = \text{Output Antenna Power}$$

For example, 30 dBm – 2 dB + 6 dBi = 34 dBm (or 2.5 Watts). 34 dBm is within the FCC and ISED limits. However, 30 dBm – 2 dB + 10 dBi = 38 dBm (or 6.3 Watts) **exceeds** the FCC ISED limits.

Cable Type	Attenuation (db/100 ft)	Run Length (ft)	Total Run Attenuation (dB)
LMR400	3.93	25	1.0
LMR500	3.154	25	0.8
LMR600	2.518	25	0.6
LMR900	1.709	25	0.4

3. Configuring Point-to-MultiPoint Networks

When installing MultiPoint networks it is important to do some up front planning around the devices to implement and the route the data is going to take back to the Master. A MultiPoint network can contain the following devices:

- Only one Master. All communications are from and to the Master.
- An unlimited number of Slave radios (remote sites).
- An unlimited number of Repeaters between any Slave and the Master.
- Serial Repeaters can be Slave radios and Repeaters at the same time.

This section provides details about the setup that applies specifically to a MultiPoint network:

- Point to MultiPoint network characteristics.
- Using the Network ID or the Call Book to establish which radios in the network can communicate with each other.
- Using subnet IDs to route traffic through the network, back to the Master.
- Settings and recommendations for additional parameters that apply to a MultiPoint network.
- Conserving power in devices within the network.
- Running network diagnostics.

Note: See [Routing Communications through the Network \(on page 71\)](#) and [Assigning Subnet ID Values \(on page 71\)](#) for additional information.

3.1. Point to MultiPoint Network Characteristics

A Point to MultiPoint network has these unique characteristics:

- [Golden Settings \(on page 63\)](#).
- [Master to Slave Communications \(on page 63\)](#).
- [Slave to Master Communications \(on page 63\)](#).

3.1.1. Golden Settings

A Point-to-MultiPoint network requires that the Golden Settings (described in [Golden Settings \(on page 44\)](#)) are set the same on **ALL** radios in the network.

If several independent MultiPoint networks are located in close proximity, the planning becomes more critical. It is very important to include as much frequency and time diversity as possible using different **Min and Max Packet Size**. In some instances the use of the **MultiMaster Sync** option may be required.

In almost all MultiPoint networks, the **Frequency Key** is the same for all radios. In other networks, where parallel Repeaters are introduced, the **Frequency Key** value needs to change.

3.1.2. Master to Slave Communications

Master - to - Slave communications within a MultiPoint network have these characteristics:

- Data packets sent from the Master include a 32-bit CRC.
- The Master repeats its data broadcast between 0 to 9 times, depending on the **Master Packet Repeat** setting. For more information, see [Master Packet Repeat \(on page 78\)](#).
- A Slave or Repeater does not send acknowledgments to the Master when it receives data.
 - When any Slave in the network receives the data packet from the Master with the 32-bit CRC, that Slave ignores any additional repeats of the data, and passes the data to its data port.
- Repeaters in the network send data to Slave radios and other Repeaters.

3.1.3. Slave to Master Communications

Slave - to - Master communications within a MultiPoint network have these characteristics:

- Data packets sent from the Slave to the Master include a 32-bit CRC.
- When the Master successfully receives data, it sends an acknowledgment to the Slave and passes the data out its data port.

3.2. Point-to-MultiPoint Network Quick Start

This is a quick start procedure for setting up two radios in Point-to-MultiPoint mode. This mode allows for a Master to communicate with several Repeaters and Slaves simultaneously.

3.2.1. Point-to-MultiPoint Network Quick Start (Tool Suite)

1. Connect the radio to a TTL-to-RS232 converter.
2. Connect to the serial port of a computer either through the data pins or diagnostics pins.
3. Connect the radio to a power source.

Important! Power supply ranges and recommendations vary depending on model. Verify the specifications for the model prior to connecting power.

4. Open a Tool Suite session.
5. Click the **Configuration** application.
6. Verify the correct port is selected in the **Com Port** field in the upper left of the **Configuration** ribbon.
7. On the **Configuration** ribbon, in the **Network** section, click the network the radio resides in or
Click **Add Network** to create a new network in Tool Suite.
8. Click **Read Radio** on the **Configuration** ribbon to read the radio's current settings.
 - If using a diagnostics cable to connect to the radio, the radio automatically goes into **Setup** mode.
 - When in **Setup** mode, all three LEDs on the radio are solid green.
 - If using a data cable to connect to the radio, follow the prompt to press the radio's **Setup** button to put it in **Setup** mode.
9. Click the **Operation Mode** tab.
10. In the **Modem Mode** field:
Select **2** to set the radio as a Point-to-MultiPoint Master.
Select **3** to set the radio as a Point-to-MultiPoint Slave.

Note: A MultiPoint network can have only one Master, unless running in **Multi-Master Sync** mode.
For more information, see [Multi-Master Sync \(on page 103\)](#).

11. Click the **Baud Rate** tab.
12. Change the **Baud Rate**, **Data Parity**, and **Modbus RTU** to match the device that the radio is to be connected to.
13. Click the **Transmission Characteristics** tab.
14. Set these parameters so they are identical on all radios in the network:
 - Frequency Key
 - Max Packet Size

3. Configuring Point-to-MultiPoint Networks

MM3-T
User & Reference Manual

- Min Packet Size
- RF Data Rate

Note: If several independent MultiPoint networks are located in close proximity, it is very important to include as much frequency and time diversity as possible through use of different **Frequency Key**, **Min and Max Packet Size**, and **Hop Table** settings.

15. Click the **MultiPoint Parameters** tab.
16. In the **Network ID** field, set to any value between **1** and **4095**.

FREEWAVE Recommends: Set the **Network ID** to the last three or four digits of the Master radio's serial number if it is below 4095.
This value must be the same in all radios in the network.

Important!: A setting of **255** disables the **Network ID** feature and enables the Call Book.

17. Send the parameter settings by either:
 - Sending all the settings for all parameters:
In the **Configuration** application, on the **Network Title** ribbon, click **All**.
 - Sending only the changed parameters:
In the **Configuration** application, on the **Network Title** ribbon, click **Quick**.

Note: This option is only available if **Read Radio** is clicked and parameter settings are NOT sent from a template to the radio.

3.2.2. Point-to-MultiPoint Network Quick Start (Terminal Interface)

1. Connect the radio to a TTL-to-RS232 converter.
2. Connect to the serial port of a computer either through the data pins or diagnostics pins.
3. Connect the radio to a power source.

Important!: Power supply ranges and recommendations vary depending on model.
Verify the specifications for the model prior to connecting power.

4. Open a terminal emulator session.



Use the Tool Suite **Setup Terminal** application if a terminal emulator is not available.

5. Connect to COMx (where 'x' is the number of the COM connected port).
6. Set these options:
 - Data Rate: **19,200**
 - Data Bits: **8**
 - Parity: **None**

3. Configuring Point-to-MultiPoint Networks

MM3-T
User & Reference Manual

- Stop Bits: **1**
 - Flow Control: **None**
7. Press the **Setup** button on the evaluation board or short Pin 2 to ground. If using the diagnostics cable, press <Shift+U>.
 - The three LEDs on the radio should all turn green **■ ■ ■**, indicating **Setup** mode.
 - The **Main** menu appears on the screen.
 8. Press <**0**> to access the **Operation Mode** menu.
 9. Press <**2**> to set the radio as a Point-to-MultiPoint Master or Press <**3**> to set the radio as a Point-to-MultiPoint Slave.
 10. Press <**Esc**> to return to the **Main** menu.

Note: A MultiPoint network can have only one Master, unless running in **Multi-Master Sync** mode.
For more information, see [Multi-Master Sync \(on page 103\)](#).

11. Press <**1**> on the **Main** menu.
12. Change the **Baud Rate**, **Data Parity**, and **Modbus RTU** to match the device that the radio is to be attached to.
13. Press <**Esc**> to return to the **Main** menu.
14. Press <**3**> in the **Main** menu.
15. Set these parameters so they are the same on all radios in the network:
 - FreqKey
 - Max Packet Size
 - Min Packet Size
 - RF Data Rate

Note: The **Frequency Key** option is located in the **F** submenu after pressing **0** to access the **Frequency Key** menu in **Main** menu **3**.

16. Press <**Esc**> to return to the **Main** menu.
17. Press <**5**> on the **Main** menu.
18. In the **Network ID** field, set the value to any value between **1** and **4095**.

Note: A **255** setting disables the **Network ID** feature and enables the Call Book.

FREEWAVE Recommends: Set the **Network ID** to the last three or four digits of the Master radio's serial number if it is below 4095.
This value must be the same in all radios in the network.

19. Press <**Esc**> to exit the **Setup** menu and resume normal radio operation.

3.3. Point-to-MultiPoint Operation LEDs

Condition	Master			Slave			Repeater		
	Carrier Detect (CD)	Transmit (Tx)	Clear to Send (CTS)	Carrier Detect (CD)	Transmit (Tx)	Clear to Send (CTS)	Carrier Detect (CD)	Transmit (Tx)	Clear to Send (CTS)
Powered, not linked	Solid red bright	Solid red dim	Off	Solid red bright	Off	Blinking red	Solid red bright	Off	Blinking red
Repeater and Slave linked to Master. No data.	Solid red bright	Solid red dim	Off	Solid green	Off	Solid red bright	Solid green	Solid red dim	Solid red bright
Repeater and Slave linked to Master. Master sending data to Slave.	Solid red bright	Solid red dim	Off	Solid green	Off	Solid red bright	Solid green	Solid red dim	Solid red bright
Repeater and Slave linked to Master. Slave sending data to Master.	Solid green RCV data or Solid red bright	Solid red dim	Intermittent flash red	Solid green	Intermittent flash red	Solid red bright	Solid green	Solid red bright	Solid red bright
Master with diagnostics program running.	Solid red bright	Solid red dim	Intermittent flash red	Solid green	Intermittent flash red	Solid red bright	Solid green	Solid red bright	Solid red bright

Note: *In an idle condition, the CTS LED is solid red with a solid link, as the link weakens the CTS LED on the Repeater and Slave begins to blink .

3.4. Overlapping MultiPoint Networks

Overlapping MultiPoint networks may be set up effectively when several key parameters are set correctly. Overlapping MultiPoint networks are defined as networks using different Master radios, which share or overlap in a specific geographic area. It may also include collocated radios configured into different networks.

For more information, see Application Note #5412, **Synchronizing Collocated Masters (Multi-Master Sync Mode)** (available from www.freewave.com).

Collocated MultiPoint networks require these parameters be unique for each network:

- Network ID (unless using the Call Book)
- Frequency Key (with Repeater Frequency)
- Max Packet Size
- Min Packet Size

Note: For more information about the installation of Point-to-MultiPoint networks, contact FreeWave Technical Support.
See [Contact FreeWave Technical Support on page 9](#)

3.5. Establishing Communication with Other Radios in a MultiPoint Network

For the radios in the network to communicate successfully, the radio needs to know what other devices are available for them to communicate with. Use the **Network ID** or the Call Book.

FREEWAVE Recommends: While the Call Book is an option in Point-to-MultiPoint networks, FreeWave **strongly recommends** using the **Network ID** feature in most applications. If a large MultiPoint network is implemented using the Call Book and a radio needs to be added to or replaced in the network, each radio in the network must be physically reprogrammed and the new serial number entered in the radio's Call Book. This can be a time consuming process and can cause a delay in getting the network back up and running. Because the **Network ID** does not use serial numbers, MultiPoint Master radios and Repeaters may be added or replaced without reprogramming each Slave radio in the network.

3.5.1. Using the Network ID in MultiPoint Networks

The **Network ID** parameter is located on the **MultiPoint Parameters** tab. In a single network, assign each radio the same **Network ID**. Slave radios link with the first Master or Repeater it hears that has a matching **Network ID**.

When setting the **Network ID**:

- The value can be any value between 1 and 4095, except 255.
 - 255 enables the Call Book.

3. Configuring Point-to-MultiPoint Networks

MM3-T
User & Reference Manual

- To help ensure the ID is unique to the network, avoid using numbers that coincide with nearby landmarks or highways.

Example: Use the last four digits of the Master serial number if it is below 4095. This is ensured to be unique and does not overlap with other nearby FreeWave networks.

- Use the **Network ID** function in conjunction with the **Subnet ID** feature (if necessary) to route data through the radio network.

3.5.2. Using the Call Book in MultiPoint Networks

Although NOT recommended, the Call Book is an option in MultiPoint networks. If the **Network ID** feature is used in a MultiPoint network, no entries are needed in the Call Book of any of the radios.

FREEWAVE Recommends: While the Call Book is an option in Point-to-MultiPoint networks, FreeWave **strongly recommends** using the **Network ID** feature in most applications. If a large MultiPoint network is implemented using the Call Book and a radio needs to be added to or replaced in the network, each radio in the network must be physically reprogrammed and the new serial number entered in the radio's Call Book. This can be a time consuming process and can cause a delay in getting the network back up and running. Because the **Network ID** does not use serial numbers, MultiPoint Master radios and Repeaters may be added or replaced without reprogramming each Slave radio in the network.

Important!: Using the Call Book in a MultiPoint network can cause delay in resuming communications if a Master is damaged.

Note: For information about setting the Call Book, see [Using the Call Book in Point-to-Point Networks on page 90](#).

In a MultiPoint network, the Slave radios and Repeaters are not listed in the Master radio's Call Book. Slave radios must have the Master and any Repeater it is going to use in its Call Book.

These examples show the Call Book of a MultiPoint network comprised of a Master, Repeater, and Slave in which the Slave can communicate either through the Repeater or directly to the Master.

MultiPoint Master Call Book (Unit Serial Number 900-0001)

Entry	Number	Repeater 1	Repeater 2
(0)	000-0000		
(1)	000-0000		

Note: No serial number entries are necessary in the Master's Call Book.

MultiPoint Repeater Call Book (Unit Serial Number 900-0002)

Entry	Number	Repeater 1	Repeater 2
(0)	900-0001		
(1)	000-0000		

MultiPoint Slave Call Book (Unit Serial Number 900-0003)

Entry	Number	Repeater 1	Repeater 2
(0)	900-0001		
(1)	900-0002		
(2)	000-0000		



At times, the Slave radios need to be forced to go through a specific MultiPoint Repeater. In this scenario, the Slave radio's Call Book should contain only the serial number for that Repeater as the entry on line 0.

3.5.3. Programming Point-to-MultiPoint Extended Call Book

In a MultiPoint network, Slave radios can be programmed to roam between Master radios and Repeaters using the MultiPoint **Extended Call Book** function. Slave radios with Call Book, as configured in this procedure, communicate with any radio whose serial number appears in any of the three columns.

Procedure

1. Set the **Network ID** to **255**.
2. In the Call Book, enter **999-9999** as the last entry in the first and second columns.
3. In the Call Book, set **Entry to Call** to **All**.

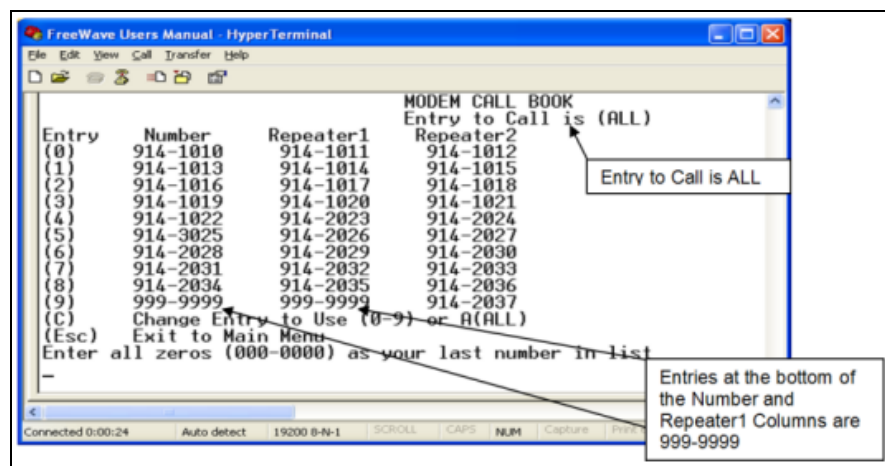
**Figure 23: HyperTerminal PTMP Extended Call Book**

3.6. Routing Communications through the Network

When using the **Network ID**, a Repeater or Slave links to the first Repeater or Master it hears with the same ID.

- Use Subnet IDs to determine the path a Repeater or Slave uses to communicate back to the Master.
- Subnet IDs are particularly helpful to force:
 - Two Repeaters in the same network to operate in series rather than in parallel.
 - Slave radios to communicate to a specific Repeater for load balancing purposes.

Note: Forcing the communications path optimizes the performance of the network by ensuring the Repeater or Slave links to a Repeater or Master with robust RF communications. Subnet IDs can help to minimize latency.

3.6.1. Assigning Subnet ID Values

Subnet IDs consist of two parts, both available on the **MultiPoint Parameters** tab:

- **Rx** - This setting identifies which radio a Repeater or Slave listens to.
 - In the terminal interface, this is the **Rcv Subnet ID**.
- **Tx** - This setting identifies the ID this device transmits on and which devices listen to it.
 - The **Tx Subnet ID** parameter is relevant for MultiPoint Master radios and Repeaters **only**.
 - In the terminal interface, this is the **Xmt Subnet ID**.
- The default (disable) setting for both **Rx** and **Tx** is **F, F**.
 - This is a visual way to indicate that the device is the final in the line of communication and does not use a subnet ID.
- A MultiPoint Slave with a **Subnet ID** of **F, F** does not roam from one Repeater or network to the next.
 - It only links to a Master or Repeater that has either a **Transmit Subnet** setting of **0** or an **F, F Subnet ID**.
- Setting both **Rx** and **Tx Subnet ID** to **0** allows a mobile Slave to roam from subnet to subnet, and possibly from network to network, provided the **Network ID**, **Max and Min Packet Size**, and **RF Data Rates** are the same between networks.

The examples in this section show the subnet definitions from the Master radio through the network to the Slave radios. When the subnet path is defined, the Slave radios can follow the route back to the Master.

Example 1: Subnet and Specific Path Communication

This example shows a network in which subnet IDs are used to force communications along a specific path.

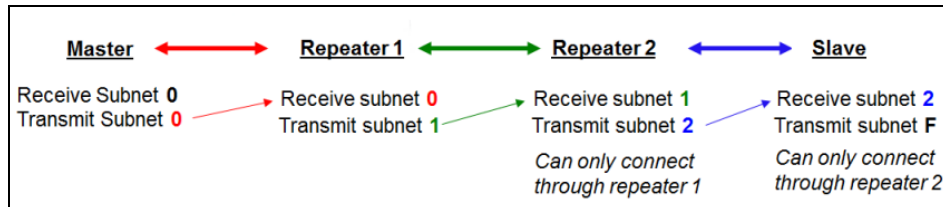

Figure 24: Subnet and Specific Path Communication

Subnet and Specific Path Communication			
Radio	Rx	Tx	Additional Information
Master	0	0	The default settings (F, F) actually use 0, 0. The Rx Subnet on the Master has no effect on the network.
Repeater 1	0	1	Rx Subnet = 0 forces the radio to link only to the Master.
Repeater 2	1	2	Rx Subnet = 1 forces communication through Repeater 1. Repeater 1 transmits on subnet 2.
Slave	2	F	Rx Subnet = 2 forces communication through Repeater 2. The Slave is the end of the network, so its Tx Subnet is F.

Example 2: Subnet and Communication Required through Repeaters

This example shows:

- Repeater 2 must communicate through Repeater 1.
- The Slave connected to Repeater 1 must route through Repeater 1.
- The other two Slave radios must route through Slave/Repeater 2.

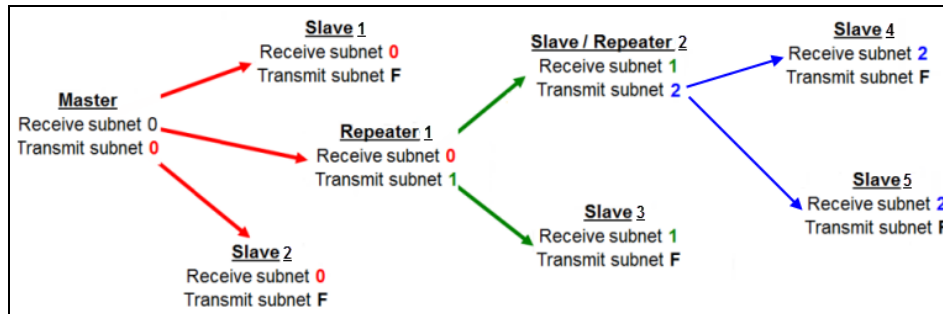

Figure 25: Subnet and Communication Required through Repeaters

Subnet and Communication Required through Repeaters			
Radio	Rx	Tx	Additional Information
Master	0	0	The default settings (F, F) actually use 0, 0. The Rx Subnet on the Master has no effect on the network.
Slave 1	0	F	Rx Subnet = 0 forces the radio to link only to the Master. The Slave does not transmit to any device except the Master, so its Tx Subnet is F.
Repeater 1	0	1	Rx Subnet = 0 forces the radio to link only to the Master. Transmits on subnet 1.
Slave 2	0	F	Rx Subnet = 0 forces the radio to link only to the Master.
Slave/Repeater 2	1	2	Rx Subnet = 1 forces the radio to link only to Repeater 1. It transmits on Tx Subnet 2 to Slave 4 and 5.
Slave 3	1	F	Rx Subnet = 1 forces the radio to link only to Repeater 1. The Slave does not transmit to any device except Repeater 1, so its Tx Subnet is F.
Slave 4	2	F	Rx Subnet = 2 forces the radio to link with Slave/Repeater 2.
Slave 5	2	F	Rx Subnet = 2 forces the radio to link with Slave/Repeater 2.

Example 3: Subnet and Optional Slave Communication

This example shows:

- Repeater 1 must talk directly to the Master.
- Repeater 2 must talk directly to Repeater 1.
- Slave 1, 2, and 3 are forced along the direction of the solid lines.
- Slave 4 may link to the first Master or Repeater it hears in the network.

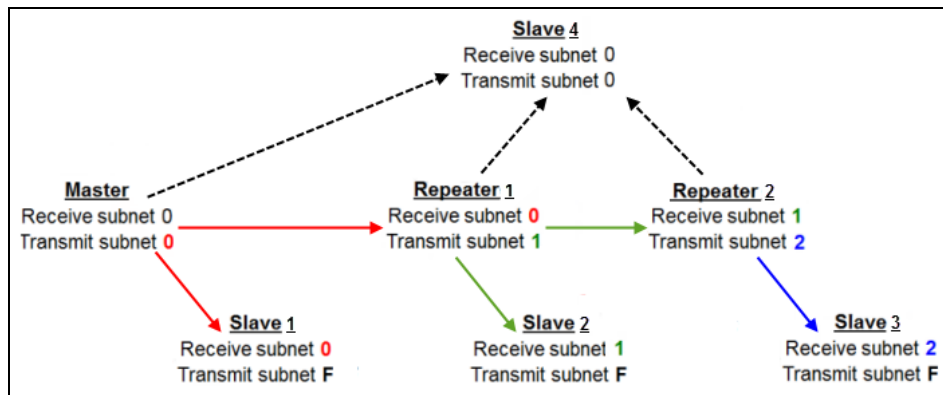

Figure 26: Subnet and Optional Slave Communication

Subnet and Optional Slave Communication			
Radio	Rx	Tx	Additional Information
Master	0 or F	0 or F	The default settings (F, F) actually use 0, 0. The Rx Subnet on the Master has no effect on the network.
Repeater 1	0	1	Rx Subnet = 0 forces the radio to link only to the Master.
Repeater 2	1	2	Rx Subnet = 1 forces communication through Repeater 1. Repeater 1 transmits on SubnetID 1.
Slave 1	0	0 or F	Rx Subnet = 0 forces communication through the Master.
Slave 2	1	0 or F	Rx Subnet = 1 forces communication through Repeater 1.
Slave 3	2	0 or F	Rx Subnet = 2 forces communication through Repeater 2.
Slave 4	0	0	The 0, 0 setting allows the Slave to link with the: <ul style="list-style-type: none"> • first Master or • Repeater it hears with the same Network ID.

3.7. Setting Other MultiPoint Parameters

The other MultiPoint Parameters options allow you to modify several different parameters in the radio that determine the characteristics of a MultiPoint network.

- In Tool Suite, set these parameters in the **MultiPoint Parameters** tab.
- These settings are available in the **MultiPoint Parameters** menu in the terminal interface.

Note: See the [Parameter Preference](#) for a description of the parameter table's content.

3.7.1. 1 PPS Enable Delay

Important! When **1 PPS** is enabled, the Master radio must have a 1 PPS pulse on its DTR pin, otherwise the RF network does not function.

1 PPS Enable Delay	
Setting	Description
Default Setting	255
Options	<ul style="list-style-type: none"> • 255 to disable 1 PPS • 0 to 254 to enter the delay
Terminal Menu	(5) Edit MultiPoint Parameters > (9) 1 PPS Enable/Delay
Description:	<p>The 1 PPS Enable/Delay setting allows a 1PPS signal to propagate from the Master to all Slave in a MultiPoint network.</p> <p>When this parameter is enabled a properly generated pulse applied on the DTR line of the Master provides a 1 PPS pulse on the CD line of any Slave in the network.</p>

Setup 1PPS Enable/Delay

1. On the Master radio, set the **1 PPS Enable/Delay** parameter to **0**.

Note: The Master must have a 1 PPS pulse on the DTR pin, otherwise the RF network will not function.

2. Enable the **1 PPS Enable/Delay** parameter on the Slave radios.
Slave radios are calibrated at the factory.

Calibrate a Slave Radio in 1PPS Enable/Delay Mode

1. On the Master radio, trigger an oscilloscope on the 1 PPS pulse on the DTR line.
2. Monitor the CD line of the Slave radio.
3. If the timing on the Slave radio differs from the Master it may be adjusted via the value in the Slave radio's **1 PPS Enable/Delay** parameter.

The difference in time between each incremental integer value is 542.534 nanoseconds (ns). Changing the parameter to higher values decreases the Slave radio time delay and changing the parameter to lower values increases the time delay.

When properly calibrated, the CD line Slave radio outputs a pulse that goes high for about 2 ms in sync with the 1 PPS pulse on the Master radio. The output on the Slave radio occurs within 20 microseconds of the input to the Master.

3.7.2. Diagnostics

Diagnostics	
Setting	Description
Default Setting	0 (Disabled)
Options	Any number between 0 and 128
Terminal Menu	(5) Edit MultiPoint Parameters > (B) Diagnostics
Description:	<p>Allows diagnostics data in the Network Diagnostics in Tool Suite to be viewed at the Master radio in parallel with application data.</p> <ul style="list-style-type: none"> • The setting in this parameter determines how many slots out of 122 are dedicated to diagnostics. • Diagnostics is always secondary to actual transmitted data. <p>Example: If set to 10, 1 out of every 10 data slots is for diagnostics data. If set to 100, 1 out of every 100 data slots is for diagnostics data.</p> <p>Note: For more information, see Reading Diagnostics in Tool Suite on page 83.</p>

3.7.3. DTR Connect

DTR Connect	
Setting	Description
Default Setting	(0) Off

3. Configuring Point-to-MultiPoint Networks

MM3-T
User & Reference Manual

DTR Connect	
Setting	Description
Options	<ul style="list-style-type: none"> • (0) Off - When set to off in the Slave radio, the radio transmits when the data is received. • (1) DTR Sensing - Forms a Point-to-Point link with the Master radio when the DTR line is high to send data. • (2) Burst Mode - The radio transmits data in bursts.
Terminal Menu	(5) MultiPoint parameters > (4) DTR Connect
Description:	<p>Determines how the radio sends its data.</p> <div style="border: 1px solid gray; padding: 5px; margin: 5px 0;"> <p>Note: This mode is valuable when a network has many low data rate devices and to increase overall network capacity.</p> </div> <p>The radio has two separate transmit and receive user data buffers of 2kb each.</p> <div style="border: 1px solid orange; padding: 5px; margin: 5px 0;"> <p> Caution: In case of a buffer overflow, the radio outputs unpredictable data.</p> </div>

3.7.4. Local Mode

Local Mode	
Setting	Description
Default Setting	(0) Disabled
Options	(0) Disabled, (1) Enabled
Terminal Menu	(5) Edit MultiPoint Parameters > (E) Local Access
Description:	<p>Enable Local Mode to access a Slave radio with a local Master radio.</p> <div style="border: 1px solid gray; padding: 5px; margin: 5px 0;"> <p>Important! This Master does NOT take the place of the network Master.</p> </div> <div style="border: 1px solid gray; padding: 5px; margin: 5px 0;"> <p>Note: For more information, see Application Note #5457, Local Mode (available from www.freewave.com).</p> </div>

3.7.5. Master Packet Repeat

Note: When using the radio in **Modbus RTU** mode, the **Master Packet Repeat** setting must match in every radio, regardless of whether the network is in Point-to-Point or MultiPoint mode.

Master Packet Repeat	
Setting	Description
Default Setting	3
Options	Any number between 0 and 9.
Terminal Menu	(5) Edit MultiPoint Parameters > (1) Master Packet Repeat
Description:	<p>In a Point-to-MultiPoint network, Slave radios do not acknowledge transmissions from the Master.</p> <ul style="list-style-type: none"> If Slave radios did acknowledge all data transmissions, in a large network, the Master would soon become overwhelmed with acknowledgments from the Slaves. Without acknowledgments, 100% confidence every Slave radio has received every packet cannot be met. To address this issue, change the Master Packet Repeat parameter, assigning a value between 0 (the packet is transmitted once) to 9 (the packet is transmitted 10 times). <p>For networks with solid RF links, this parameter should be set to a low value (e.g., 1 or 2).</p> <ul style="list-style-type: none"> If a network has some weak or marginal links it should be set with higher values. If a Slave radio receives a good packet from a Master more than once it discards the repeated packets. Similarly, after a MultiPoint Repeater receives a good packet from the Master, it discards any further repeated packets. In turn, the Repeater sends the packet out to the next Repeater or Slaves the number of times corresponding to its own Master Packet Repeat setting. <p>Increasing the Master Packet Repeat setting increases the probability of a packet getting through, but also increases latency in the network because each packet from the Master or Repeater is being sent multiple times.</p> <div style="border: 1px solid black; padding: 5px; margin: 10px 0;"> <p>Note: Therefore, it is important to find the optimal mix between network robustness, throughput, and latency. In general, a setting of 2 to 3 works well for most well designed networks.</p> </div> <p>The Master Packet Repeat parameter may be set to 0 if the user software is capable of, or requires acknowledgment.</p> <p>In this case, if the Master sends a packet that the Slave radio does not receive, the user software controls the retries as needed.</p>

3.7.6. Master Packet Repeat in MultiPoint Networks with Repeaters

The **Master Packet Repeat** parameter must be set in MultiPoint Repeaters because a Repeater appears as a Master to a Slave radio.

Therefore, the Repeater sends the packet out the number of times corresponding to its own **Master Packet Repeat** parameter setting. If this parameter is set improperly the reliability of the overall network may be diminished.

Example: If a Master's **Master Packet Repeat** parameter setting is **3**, the link between the Master and Repeater should be robust.
If the Repeater's **Master Packet Repeat** parameter setting is **0**, this could cause marginal links between the Repeater and the Slaves.
The Slaves communicating through this Repeater only receive the initial packet from the Master with no repeats.
Therefore, if the packet is not received on the first try, the Slave radio does not respond as expected.

Note: The **Master Packet Repeat** parameter setting in any MultiPoint Repeater must be **less than or equal** to the Master's setting.

3.7.7. Max Slave Retry

Max Slave Retry	
Setting	Description
Default Setting	9
Options	Any number between 1 and 9.
Terminal Menu	(5) Edit MultiPoint Parameters > (2) Max Slave Retry
Description:	<ul style="list-style-type: none"> Defines how many times the Slave radio attempts to retransmit a packet to the Master before beginning to use a back-off algorithm as defined by the Retry Odds on page 81 setting. The Slave radio retries stop when the Slave receives an acknowledgment from the Master.

3.7.8. Radio ID

Radio ID	
Setting	Description
Default Setting	Blank
Options	Any 4 digit, user-defined number.
Terminal Menu	(5) Edit MultiPoint Parameters > (D) Radio ID
Description:	Use this option to designate a radio with an arbitrary, user-defined, 4-digit number that identifies the radio in Diagnostics mode.

3.7.9. Radio Name

Radio Name	
Setting	Description
Default Setting	Blank
Options	A maximum of 20 characters in any combination of letters or numbers.
Terminal Menu	(5) Edit MultiPoint Parameters > (G) Radio Name
Description:	Use this parameter to give a radio a name, such as its location. <div style="border: 1px solid gray; padding: 5px; margin-top: 10px;">  Naming radios can be helpful to identify a radio when in Diagnostics mode. </div>

3.7.10. Repeaters

Note: This parameter needs to be set in the MultiPoint Master only. The setting has no effect if set in a MultiPoint Slave.

Repeaters	
Setting	Description
Default Setting	(1) Enabled
Options	<ul style="list-style-type: none"> • 0 - Disabled • 1 - Enabled
Terminal Menu	(5) Edit MultiPoint Parameters > (0) Number Repeaters
Description:	Indicates if any number of Repeaters exist in the network.

3.7.11. Repeater Frequency

Repeater Frequency	
Setting	Description
Default Setting	(0) Disabled
Options	(0) Disabled (1) Enabled
Terminal Menu	(5) Edit MultiPoint Parameters > (5) Repeater Frequency
Description:	<p>Enable this parameter when a Frequency Key is needed other than that of the Master.</p> <ul style="list-style-type: none">This condition occurs when parallel Repeaters in a network may have overlapping areas of responsibility.The default setting of 0 (Disabled) causes the Repeater to use the key set in the Frequency Key parameter on the Tool Suite Transmission Characteristics tab. <div style="border: 1px solid black; padding: 5px;"><p>Note: When the Repeater Frequency parameter is disabled and Subnets are NOT configured, the Frequency Key parameter setting in each Slave radio MUST match the Master or Repeater acting as the Master for the radio.</p></div>

3.7.12. Retry Odds

Retry Odds	
Setting	Description
Default Setting	0
Options	Any number between 0 and 9.
Terminal Menu	(5) Edit MultiPoint Parameters > (3) Retry Odds

Retry Odds	
Setting	Description
Description:	<p>While packets transmitted from the Master to the Slave radios in a MultiPoint network are not acknowledged, packets transmitted from Slaves to the Master are acknowledged.</p> <p>It is possible that more than one Slave attempts to transmit to the Master at the same time. Therefore, it is important that a protocol exists to resolve contention for the Master between Slaves in the network.</p> <p>This is addressed through the Max Slave Retry (on page 79) and Retry Odds parameters.</p> <ul style="list-style-type: none"> • After the Slave has unsuccessfully attempted to transmit the packet the number of times specified in the Max Slave Retry parameter, it attempts to transmit to the Master on a random basis. • The Retry Odds parameter determines the probability that the Slave attempts to retransmit the packet to the Master; a low setting assigns low odds to the Slave attempting to transmit. • Conversely, a high setting assigns higher odds. <div style="border: 1px solid gray; padding: 5px; margin: 10px 0;"> <p>Example: Consider two different Slave radios in a MultiPoint network, one with a strong RF link and the other with a weak RF link to the Master.</p> <p>If a Slave has a weak or poor link, set the Retry Odds parameter to 0 as it may become a chatty Slave and lockup the network, causing a loss of communication.</p> </div> <ul style="list-style-type: none"> • When the Retry Odds parameter is set to 0, after the Slave has exhausted the number of retries set in the Max Slave Retry parameter and still not gained the Master's attention, the Slave's data buffer is purged. <div style="border: 1px solid gray; padding: 5px; margin: 10px 0;"> <p>FREEWAVE Recommends: A Retry Odds parameter set to 0 is recommended for most networks.</p> </div>

3.7.13. Slave / Repeater

Slave / Repeater	
Setting	Description
Default Setting	(0) Disabled
Options	(0) Disabled (1) Enabled
Terminal Menu	(5) MultiPoint Parameters > (A) Slave/Repeater

Slave / Repeater	
Setting	Description
Description:	<p>The Slave/Repeater mode allows a radio in a MultiPoint network to switch between Slave and Repeater functions.</p> <ul style="list-style-type: none"> • When in this mode, a radio repeats any packets sent across the network as well as uses the data port. • Thus, where one Repeater and one Slave may be required in another vendor's network, FreeWave networks require only one radio. <p>To operate a radio as a MultiPoint Slave/Repeater, these parameters must be set:</p> <ul style="list-style-type: none"> • The Modem Mode parameter in the Operation Mode tab must be set to MultiPoint Repeater. • The Slave/Repeater parameter in the MultiPoint Parameters tab must be enabled.

3.8. Reading Diagnostics in Tool Suite

The **Network Diagnostics** application provides a place to view diagnostic data for all the devices connected to the Master in the network in real time.

Important! The **Network Diagnostics** application is NOT meant to replicate the functionality of a Network Management System. It is a tool intended for occasional network monitoring or troubleshooting in the field, not for continuous, long-term collection of diagnostic data.

This section provides basic steps for reading diagnostics using Tool Suite. Tool Suite stores the diagnostic data in the database for import from or export to a diagnostic file.

For information regarding the data available, recommended best practices, and importing and exporting files using the **Network Diagnostics** application, see the **Tool Suite User Manual** available in the Tool Suite software.



To help identify the radios in the network when running **Network Diagnostics**, set the **Radio Name** and **Radio ID** fields on the **MultiPoint Parameters** tab.

The diagnostic program **must** be run from the Master radio. Diagnostics require:

- A setting between 1 and 128 in the **Diagnostics** parameter available in the MultiPoint Parameters menu on the Master.
- A second computer or serial connection to run the diagnostics software.
- A diagnostics cable. (Available from FreeWave.)
- Diagnostics software. (Available from www.freewave.com).

Note: For more information about diagnostics, contact FreeWave Technical Support. [Contact FreeWave Technical Support \(on page 9\)](#) for assistance.

Procedure

1. Connect the Master to the computer running Tool Suite.
2. Open Tool Suite.
3. On the Applications tab, click **Network Diagnostics**.
4. In the **Networks** section of the ribbon, use the list box to select the serial network to run diagnostics on.

If there is no network defined, click **Add** and follow the instructions in the wizard.

5. On the ribbon, click **Start**.
6. To stop running diagnostics, click **Stop**.

Note: The **Network Diagnostics** application continues to poll for diagnostic data until it is stopped.

Important! Tool Suite is NOT optimized for the collection and management of large amounts of diagnostic data from continuous polling. Collection of excessive amounts of data results in overall performance degradation in Tool Suite and network throughput degradation.

4. Configuring Point-to-Point Networks

Point-to-Point networks are the most basic type of network and do not require much more than the setup described in the basic programming and setup section.

This section provides:

- A brief quick start to setup a Point-to-Point network.
- An LED chart for LED function within a Point-to-Point network.
- Information about programming the Call Book.

4.1. Point-to-Point Network Quick Start

To establish a link between a pair of FreeWave radios just received from the factory, complete these steps for each radio.

4.1.1. Point-to-Point Network Quick Start (Tool Suite)

1. For board level configuration, connect the radio to a TTL-to-RS232 converter then connect to the serial port of a computer either through the data pins or diagnostics pins.
2. Connect the radio to a power source.

Note: Power supply ranges and recommendations vary depending on model. Verify the specifications for the model you are using prior to connecting power.

3. Open a Tool Suite session.
4. Click the **Configuration** application.
5. Verify the correct port is selected in the **Com Port** field in the **Configuration** ribbon.
6. On the **Configuration** ribbon, in the **Networks** section, select the network the radio resides in or click **Add Network** to create a new network in Tool Suite.

4. Configuring Point-to-Point Networks

MM3-T
User & Reference Manual

7. Click **Read Radio** on the **Configuration** ribbon to read the radio's current settings.
 - If using a diagnostics cable to connect to the radio, the radio automatically goes into **Setup** mode.
 - If using a data cable to connect to the radio, a prompt appears to press the radio's **Setup** button to enter **Setup** mode.
 - When in **Setup** mode, all three LEDs on the radio display solid green ■ ■ ■.
8. Click the **Operation Mode** tab.
9. In the **Modem Mode** field, select to set the radio to Point-to-Point mode.

Example: Set one radio as a Point-to-Point Master (Mode 0) and the other as a Point-to-Point Slave (Mode 1).

Note: A Point-to-Point network can have only one Master.
For more information about modem modes, see [Setting the Radio's Role in the Network and the Network Type \(on page 35\)](#).

10. Click the **Baud Rate** tab.
11. Change the **Baud Rate**, **Data Parity**, and **Modbus RTU** to match the device that the radio is to be attached to.
12. Click the **Transmission Characteristics** tab.
13. Set these parameters so they are identical on all radios in the network:
 - Frequency Key
 - Max Packet Size
 - Min Packet Size
 - RF Data Rate

If several independent networks are located in close proximity, it becomes very important to include as much frequency and time diversity as possible through use of different **Frequency Key**, **Min and Max Packet Size**, and **Hop Table** parameter settings.
14. Click the Call Book tab.
15. Enter the Slave serial number in the Master's Call Book.
16. Enter the Master's Serial number in the Slave's Call Book, or disable the **Slave Security** parameter in the Slave.

Note: For more information about setting up the Call Book see [Using the Call Book in Point-to-Point Networks \(on page 90\)](#).

Shortly after both radios are plugged in, they should establish a link with each other and the connection is complete.

17. Using the [Point-to-Point Operation LEDs \(on page 89\)](#), verify that the radios are operating as expected.
18. On the **Configuration** application in the **Network Title** ribbon:

4. Configuring Point-to-Point Networks

MM3-T
User & Reference Manual

- Click **All** to send all the settings for all parameters.
- Click **Quick** to send only the changed parameters.

Note: **Quick** is only available if **Read Radio** is selected and parameter settings are NOT sent from a template to the radio.

4.1.2. Point-to-Point Network Quick Start (Terminal Interface)

1. For board level configuration, connect the radio to a TTL-to-RS232 converter then connect to the serial port of a computer either through the data pins or diagnostics pins.
2. Connect the radio to a power source.

Note: Power supply ranges and recommendations vary depending on model. Verify the specifications for the model you are using prior to connecting power.

3. Open a terminal emulator session.

Note: Use the **Setup Terminal** application in Tool Suite if a terminal emulator is unavailable.

4. Connect to COMx (where 'x' is the number of the COM port being connected).
5. Set these parameters to:

- Data Rate - **19,200**
- Data Bits - **8**
- Parity - **none**
- Stop bits - **1**
- Flow Control - **none**

6. Press the **Setup** button on the radio.

If using the diagnostics cable, press <Shift+U>.

- When in **Setup** mode, all three LEDs on the radio display solid green .
- The **Main Menu** appears in the window.

7. Type **0** and press <Enter> to access the **Operation Mode** menu.
8. Type **0** and press <Enter> to set the radio as a Point-to-Point Master or
Type **1** and press <Enter> to set the radio as Point-to-Point Slave.

Note: For more information about modem modes, see [Setting the Radio's Role in the Network and the Network Type \(on page 35\)](#).

9. Press <**Esc**> to return to the **Main** menu.
10. On the **Main Menu**, type **1** and press <Enter>.
11. Change the **Baud Rate**, **Data Parity**, and **Modbus RTU** to match the device that the radio is to be attached to.
12. Press <**Esc**> to return to the **Main** menu.
13. On the **Main Menu**, type **2** and press <Enter> to update the Call Book.

4. Configuring Point-to-Point Networks

MM3-T
User & Reference Manual

14. Enter the Slave serial number in the Master's Call Book.
15. Enter the Master's Serial number in the Slave's Call Book or disable the [Slave Security \(on page 59\)](#) parameter in the Slave.

Note: For more information about setting up the Call Book see [Using the Call Book in Point-to-Point Networks \(on page 90\)](#).

16. On the **Main Menu**, type **3** and press <Enter>.
- 17.
18. Press <**3**> on the **Main** menu.
19. Set these parameters so they are identical on all radios in the network:
 - Frequency Key
 - Max Packet Size
 - Min Packet Size
 - RF Data Rate



































































Note: The **Frequency Key** option is located in the **F** submenu after you press <**0**> to access the **Frequency Key** menu on **Main** menu <**3**>.

20. Press <**Esc**> to return to the **Main** menu.
Shortly after both radios are plugged in, they should establish a link with each other and the connection is complete.
21. Using the [Point-to-Point Operation LEDs \(on page 89\)](#), verify that the radios are operating as expected.
22. Press <**Esc**> to exit the **Setup** menu and resume normal radio operation.

4. Configuring Point-to-Point Networks

MM3-T User & Reference Manual

4.2. Point-to-Point Operation LEDs

Condition	Master			Slave			Repeater		
	Carrier Detect (CD)	Transmit (Tx)	Clear to Send (CTS)	Carrier Detect (CD)	Transmit (Tx)	Clear to Send (CTS)	Carrier Detect (CD)	Transmit (Tx)	Clear to Send (CTS)
Powered, no link	Solid red bright 	Solid red bright 	Solid red bright 	Solid red bright 	Off 	Blinking red 	Solid red bright 	Off 	Blinking red 
Linked. No Repeater Sending sparse data	Solid green 	Intermittent flash red  	Intermittent flash red  	Solid green 	Intermittent flash red  	Intermittent flash red  	N/A	N/A	N/A
Master calling Slave through Repeater	Solid red bright 	Solid red dim 	Solid red bright 	Solid red bright 	Off 	Blinking red 	Solid red bright 	Off 	Blinking red 
Master linked to Repeater, not to Slave	Flashing orange 	Solid red dim 	Solid red bright 	Solid red bright 	Off 	Blinking red 	Solid Red bright 	Solid red dim 	Solid red bright 
Repeater linked to Slave	Solid green 	Intermittent flash red  	Intermittent flash red  	Solid green 	Intermittent flash red  	Intermittent flash red  	Solid green 	Intermittent flash red  	Intermittent flash red  
Mode 6 Waiting for ATD command	Solid red bright 	Off 	Blinking red 	Solid red bright 	Off 	Blinking red 	N/A	N/A	N/A
Setup Mode	Solid green 	Solid green 	Solid green 	Solid green 	Solid green 	Solid green 	Solid green 	Solid green 	Solid green 

4.3. Using the Call Book in Point-to-Point Networks

Using the Call Book offers both security and flexibility in determining how FreeWave radios communicate with each other.

Important!: The Call Book is required in Point-to-Point networks.

FREEWAVE Recommends: While the Call Book is an option in Point-to-MultiPoint networks, FreeWave **strongly recommends** using the **Network ID** feature in most applications. If a large MultiPoint network is implemented using the Call Book and a radio needs to be added to or replaced in the network, each radio in the network must be physically reprogrammed and the new serial number entered in the radio's Call Book. This can be a time consuming process and can cause a delay in getting the network back up and running. Because the **Network ID** does not use serial numbers, MultiPoint Master radios and Repeaters may be added or replaced without reprogramming each Slave radio in the network.

- The Call Book allows a maximum of 10 FreeWave radios.
 - Designate 1 to 4 Repeaters to use with each radio.
 - Designate which Slave the Master calls.

These settings are required for two FreeWave radios to communicate in Point-to-Point mode:

1. The Master radio serial number must be listed in the Slave radio's Call Book or **Slave Security** is turned off in the Slave.
2. The Slave serial number must be listed in the Master Call Book .
3. The Master must be programmed to call the Slave (**Entry to Call** option).
 - a. Select the number in the **Entry to Call** field, select **All** to direct the Master to call all Slave radios.

Note: To set the **Entry to Call** option in the terminal interface, press <C> at the Call Book menu, followed by the menu number corresponding to that Slave. To call any available Slave in the list, press <C> then press <A> to direct the Master to **Call All**.

It is important that the Call Book slots (0-9) are filled sequentially starting with slot 0.

- When a Master is instructed to **Call All**, it calls all Slave radios listed until it reaches the first serial number of 000-0000 (or a blank slot).
- If a serial number is entered after the all zero number or as a Repeater, the Master does not recognize it as a valid number.

Note: When entering numbers into the Call Book, define only the Repeaters in the Master's Call Book. The Slave's Call Book only requires the Master serial number. A Repeater need not have anything listed in its Call Book.

4.3.1. Setting the Call Book in Tool Suite

1. In the Tool Suite **Configuration** application, select the device to program.
2. Click the **(2) Call Book** tab.
3. In the **Number** column in **Row 0**, enter the seven-digit serial number of the radio being called.
4. In the **Repeater 1** column, enter the first Repeater's seven-digit number.
If no Repeaters are being used, leave the column empty.
5. In the **Repeater 2** column, enter the second Repeater's 7-digit number.
If only one Repeater is being used, leave the column empty.
6. If Repeaters are being used, select the appropriate **Entry to Call** option in the Master Call Book.
7. To apply the changes, click either the **Quick** or **All** icon.
Tool Suite applies the changes to the radio.

4.3.2. Setting the Call Book in the Terminal Interface

1. On the **Setup** menu, click **C(2) Edit all Book**.
The **Modem Call Book** window opens.

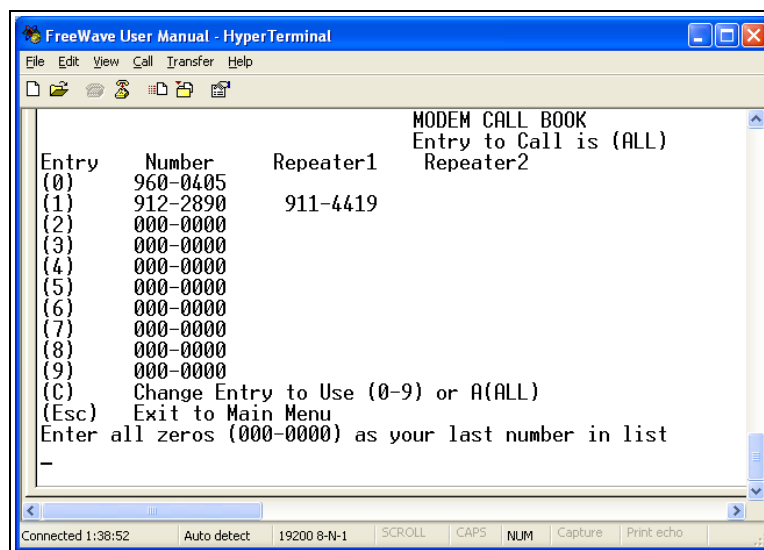

Figure 27: Modem Call Book window

2. Enter the number or letter associated with the option to select.
3. In the **Enter New Number** prompt, enter the seven-digit serial number of the radio being called.
The system prompts for the first Repeater's serial number.
4. If no Repeaters are being used, press <Esc> and continue.
Otherwise, enter the 7-digit serial number of the Repeater.
The system prompts for the second Repeater's serial number.

4. Configuring Point-to-Point Networks

5. Enter the 7-digit serial number of the second Repeater.
If only one Repeater is being used, press <Esc>.
The system refreshes the radio's **Call Book** menu with the new changes.
6. Repeat steps 2 to 5 for additional radios in the network.
7. Press <Esc> to return to the Main menu.

4.3.3. Programming Point-To-Point Extended Call Book to Use Three or Four Repeaters

In a Point-to-Point configuration, FreeWave radios can use a maximum of four Repeaters.

1. To use three or four Repeaters, program the Call Book with the Slave serial number, followed by the first two Repeaters.
2. On the next line enter 999-9999 as the radio to call.
3. When prompted for the Repeaters enter the third and fourth Repeaters in the link.

Figure 28 shows a Point-to-Point link where a Slave is called through four Repeaters. In this example:

- the Master is calling the Slave, 571-3872, through Repeater 1, 901-1234,
 - then Repeater 2, 910-0234,
 - then Repeater 3, 571-3456, and finally
 - Repeater 4, 571-4567.
- Entering the serial number 999-9999 in line 1 instructs the Master to continue calling through the Repeaters programmed on that line.

Entry	Number	Repeater 1	Repeater 2
0	571-3872	901-1234	910-0234
1	999-9999	571-3456	571-4567
2			
3			
4			
5			
6			
7			
8			
9			

Figure 28: Point-to-Point link where a Slave is called through four Repeaters

- To call a Slave radio through one or more Repeaters, that Slave must be called individually.
- With **Call All** selected, the Master will not connect with any Slave radios through Repeaters.
- The Master calls every Slave in the list and connects with the first Slave that responds.
- When calling through a Repeater, the Master must first call that Repeater and establish a communications link with it prior to making contact with the Slave.

5. Advanced Programming

The settings and scenarios covered in this section are considered advanced programming.

- [Working with Parallel Repeaters \(on page 95\)](#)
- [Setting and Changing Radio Passwords \(on page 97\)](#)
- [Enable and Set Up AES Encryption \(on page 98\)](#)
 - [Encryption Channel Key \(on page 102\)](#)
 - [Encryption Key \(on page 100\)](#)
 - [Encryption \(Strength\) \(on page 99\)](#)
 - [Troubleshooting AES Setup \(on page 102\)](#)
- [Low Baud Rates \(on page 103\)](#)
- [Multi-Master Sync \(on page 103\)](#)
- [Time Divisible Multiple Access \(TDMA\) \(on page 103\)](#)

5.1. Working with Parallel Repeaters

When Repeaters are added to a network, plan accordingly to avoid creating a parallel Repeater scenario. A parallel Repeater is defined as two or more Repeaters linked to the same point in the network.

- [Repeaters Data Transmitted on the Same Frequency Key \(on page 95\)](#)
- [Adding a Repeater to the Network \(on page 96\)](#)

5.1.1. Repeaters Data Transmitted on the Same Frequency Key

In this diagram, the Slave radio in the middle has overlapping coverage from both the Repeaters (parallel Repeaters). Data from the Repeaters is transmitted on the same **Frequency Key** in the same time slot, which creates message collisions.

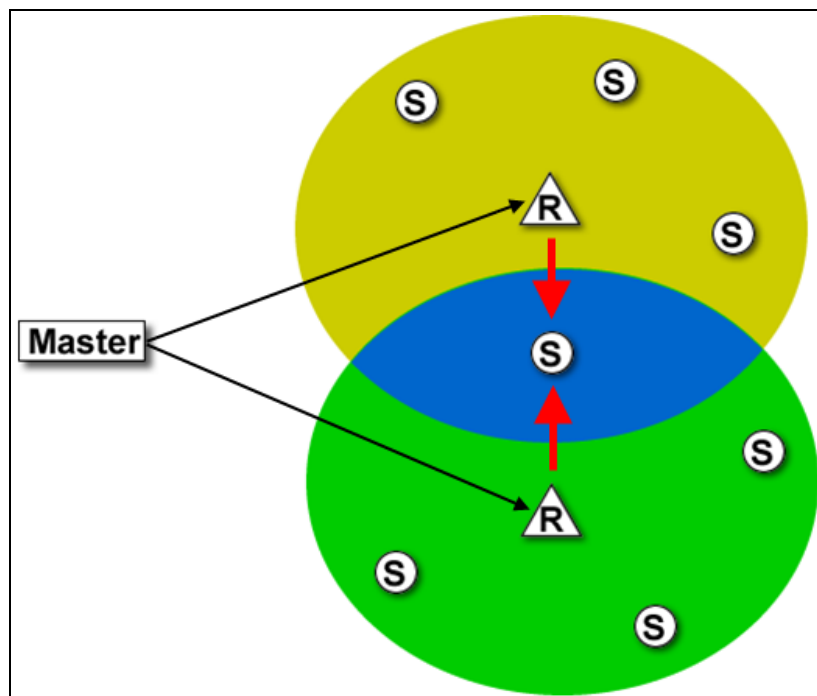

Figure 29: Slave Radio with Overlapping Coverage

To resolve this scenario, change these settings on one or more of the Repeaters in conflict:

Settings to Change on Repeaters in Conflict	
Setting	Description
Repeater Frequency	<ul style="list-style-type: none"> • Set the Repeater Frequency parameter in the MultiPoint Parameters tab to any number other than 0. • If set to a number other than 0, the radio uses the frequency key set in the Frequency Key parameter in the Transmission Characteristics tab, instead of the frequency key assigned to the Master.

Settings to Change on Repeaters in Conflict	
Setting	Description
Frequency Key	Set the Frequency Key parameter in the Transmission Characteristics tab to a key other than that of the conflicting Repeater.

5.1.2. Adding a Repeater to the Network

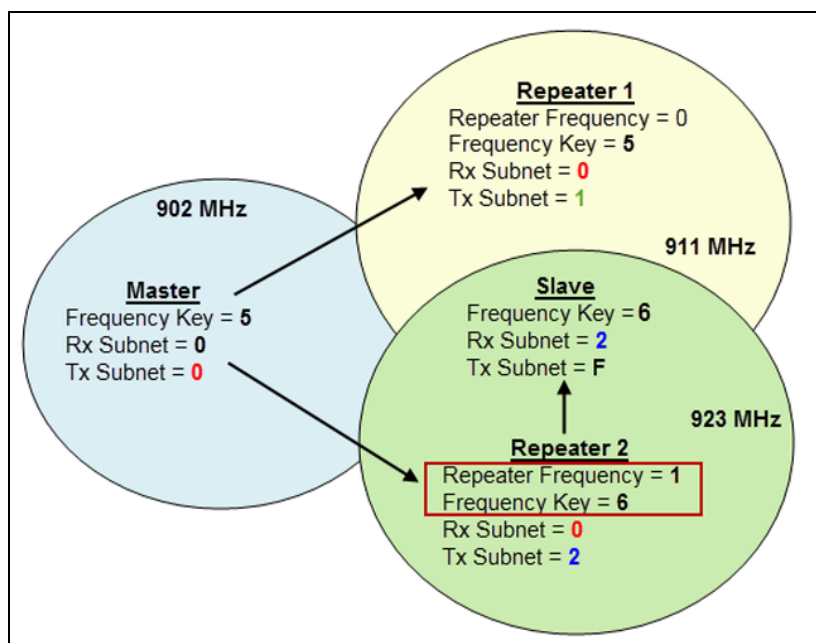

Figure 30: Repeater Added to Network

If a Repeater needs to be added to the network, use these steps to ensure any parallel Repeater issues are resolved before deploying the Repeater in the network.

1. In Tool Suite, run a network diagnostics file.



Gather the settings from all the Repeaters that are currently in the network.

2. Review the network diagnostics file.
Pay special attention to these settings on each Repeater and the Master:
 - Frequency Key
 - Repeater Frequency
 - Rx and Tx Subnet IDs
3. On a piece of paper, draw the network.
4. Note the above settings for each Repeater.
Verify there are no duplicates.
5. If there are duplicates, change the **Repeater Frequency** and the **Frequency Key** parameters described in the table.

6. If the Repeater being adding is the only Repeater in the network, set the:
 - a. **Frequency Key** parameter to match the Master.
 - b. **Rx Subnet ID** parameter to match the Master's **Tx Subnet ID** parameter setting
 - c. **Tx Subnet ID** parameter to **1**.
 - d. In the Master, set the **Repeaters** parameter to **Enabled**.

5.2. Setting and Changing Radio Passwords

Use passwords to prevent access to or changing of any of the radio's parameters. This option is useful to prevent unauthorized personnel from gaining access to the radio settings.

Note: If the **Setup Port** option on the **Baud Rate** tab is set to **(1) Main Only** or **(3) Both**, the password is only accepted if the option is accessed from the main data port. To use the Password function using the diagnostics port, the **Setup Port** option must be set to **(2) Diagnostics Only**.



Warning! If the password feature is enabled and the password is forgotten, the radio **MUST** be returned to FreeWave to have the password disabled.

5.2.1. Setting the Password

1. On the **Setup** menu in the terminal interface, select **(8) Chg Password**.
New PW? (<esc> to exit) appears.

Note: Press <Esc> to cancel the process at any time.

2. Enter **exactly** four characters.
Passwords are case sensitive.
<Enter> to accept, <esc> to quit appears.
3. Press <Enter> to accept the password and enable the feature.
Press <Esc> to quit the process and not enable the password.

Important! Press <Enter> and the password appears on the line above.
The password is case sensitive and every keystroke is a character.

5.2.2. Changing a Password

After the password feature has been enabled, it is possible to change to a new password.

1. On the **Setup** menu in the terminal interface, select **(8) Chg Password**.
The **Enter Security Code** prompt appears.
2. Enter the current four character, case-sensitive password.
The prompt to enter the new password appears.
3. Re-enter the new four character, case-sensitive password.

Note: Press <Esc> to cancel the process at any time.

4. Press <Enter> to accept the password and enable the feature.
Press <Esc> to quit the process and not enable the password.

Important! Press <Enter> and the password appears on the line above.
The password is case sensitive and every keystroke is a character.

5.2.3. Disable a Password

After the password features has been enabled, it is possible to disable the password **if the current password is known**.

Important! The password can only be disabled using the prompt when reading the radio in Tool Suite or through a terminal emulator.
The password CANNOT be disabled using **Setup Terminal** application in Tool Suite.

1. On the **Setup** menu in the terminal interface, select **(8) Chg Password**.
2. Hold down the <Alt> key and type **0255** using the number pad on the keyboard.
3. Release the <Alt> key.
4. Repeat this step three more times (hold <Alt> and type **0255** a total of 4 times).

Important! Type the **0255** using the NUM Pad on the keyboard, NOT the top row of numerals.

5. After the fourth entry, the password is disabled.

5.3. Enable and Set Up AES Encryption

Protecting the confidentiality, integrity, and authenticity of data communications is essential to maintaining a robust, reliable, and secure wireless infrastructure. FreeWave has incorporated a number of mechanisms to achieve these critical security objectives, including the use of AES encryption. When available and enabled, AES encryption adds a layer of 128-bit, 192-bit, or 256-bit encryption strength to the data before it is sent over the RF link.

Note: AES encryption is available as an option set at the factory in firmware v11.00.11 and later in some MM3-T models.

When using AES encryption, these settings are required:

- [Encryption Channel Key \(on page 102\)](#).
- [Encryption Key \(on page 100\)](#).
- [Encryption \(Strength\) \(on page 99\)](#).

Important! These settings are ONLY available in the **(3) Edit Radio Transmission Characteristics > (E) Encryption** menu in the terminal interface. These settings are NOT available in Tool Suite.

Note: For information about accessing the **Setup** menu using the terminal interface, see [Access the Setup Menu Using a Terminal Emulator \(on page 27\)](#).

Important! When AES is enabled, every radio in the network must have matching encryption strengths, encryption keys, and encryption channel keys, and the **MCU Speed** parameter set to **3** for successful communication and data transmission.

5.3.1. Encryption (Strength)

Note: AES encryption settings are available only through the **Setup** menu in the terminal interface. If the radio does not have **Encryption** enabled, menu option **E** in the **(3) Edit Radio Transmission Characteristics** menu is blank and has no function.

Important! This setting MUST match across all radios in the network.

Encryption (Strength)	
Setting	Description
Default Setting	(0) Off
Options	<ul style="list-style-type: none"> • (0) Off - Turns off AES encryption. • (2) AES 128 - Enables AES encryption, 128-bit strength. • (3) AES 192 - Enables AES encryption, 192-bit strength. • (4) AES 256 - Enables AES encryption, 256-bit strength. <p>The options available for selection are based on the encryption strength set at the factory, or within the upgrade to use AES completed with FreeWave technical support's assistance.</p> <div style="border: 1px solid gray; padding: 5px; margin: 5px 0;"> <p>Example: If the radio is factory set to include AES 256, then each strength option is available. However, if the radio is factory set to include AES 192, then only Off, AES 128, and AES 192 are available.</p> </div> <div style="border: 1px solid gray; padding: 5px; margin: 5px 0;"> <p>Note: Selecting any option other than (0) Off enables AES encryption. The encryption key and the channel key are required for successful communication.</p> </div>
Terminal Menu	(3) Edit Radio Transmission Characteristics > (E) Encryption

Encryption (Strength)	
Setting	Description
Description:	<p>AES encryption is available in various strengths.</p> <ul style="list-style-type: none"> The network and the data being sent determine the encryption strength used. The higher the encryption strength, the stronger the encryption although it can also take longer for the encryption and un-encryption to take place.

5.3.2. Encryption Key

Note: AES encryption settings are available only through the **Setup** menu in the terminal interface. If the radio does not have **Encryption** enabled, menu option **E** in the (3) Edit Radio Transmission Characteristics menu is blank and has no function.

Important!: This setting **MUST** match across all radios in the network.

Encryption Key	
Setting	Description
Default Setting	Blank
Options	Any set of hexadecimal pairs identified in Description .
Terminal Menu	(3) Edit Radio Transmission Characteristics > (E) Encryption > (5) Enter Key

Encryption Key	
Setting	Description
Description:	<p>The encryption key is the piece of information used to encrypt and un-encrypt the data sent through the network. Even with encryption, the data is only as secure as the strength of the encryption key used.</p> <p>Keys should be random and entered as hexadecimal values (i.e., 0 to F in two-character pairs). Any combination of characters can be used for the key.</p> <div style="border: 1px solid gray; padding: 5px; margin: 10px 0;"><p>Example: A combination of numbers, or a sentence or phrase converted into hexadecimal format. Various string-to-hexadecimal converters are available on the Internet.</p></div> <p>Enter the encryption key in 2-character hexadecimal combinations in the lines provided:</p> <div style="border: 1px solid gray; padding: 5px; margin: 10px 0;"><pre>Enter Choice e 0=Off, 2=AES128, 3=AES192, 4=AES256, 5=Enter Key 6=Channel Key 00 34 01 a5 02 6d 03 45 04 76 05 23 06 1a 07 0e 08 87 09 43 0A 11 0B 0b 0C 22 0D 19 0E 90 0F 75 10 61 11 07 12 56 13 a3 14</pre></div> <p>The Enter Key option always asks for all 32 lines of the encryption key. However, the encryption strength you select determines how many of the lines are required:</p> <ul style="list-style-type: none">• 128-bit encryption - Enter key information in rows 00 to 0F.<ul style="list-style-type: none">• The last 16 lines (10 to 1F) are ignored.• 192-bit encryption - Enter key information in rows 00 to 17.<ul style="list-style-type: none">• The last 8 entries (18 to 1F) are ignored.• 256-bit encryption - Enter key information in rows 00 to 1F.<ul style="list-style-type: none">• All lines are used.

5.3.3. Encryption Channel Key

Note: AES encryption settings are available only through the Setup menu in the terminal interface. If the radio does not have **Encryption** enabled, menu option **E** in the **(3) Edit Radio Transmission Characteristics** menu is blank and has no function.

Important!: This setting MUST match across all radios in the network.

Encryption Channel Key	
Setting	Description
Default Setting	Blank
Options	Any set of hexadecimal pairs identified in Description .
Terminal Menu	(3) Edit Radio Transmission Characteristics > (E) Encryption > (6) Channel Key
Description:	<p>The channel key is required when AES encryption is enabled for radios in the network to link when AES encryption is enabled.</p> <p>This setting is different from the Encryption Key parameter because it does not encrypt the actual data but is required with the other Golden Settings, described in a network, for the communication to take place.</p> <p>Channel keys should be random and entered as hexadecimal values (e.g., 0 to F in two-character pairs). Any combination of characters can be used for the key.</p> <div style="border: 1px solid gray; padding: 5px; margin: 10px 0;"> <p>Example: A combination of numbers, or a sentence or phrase converted into hexadecimal format. Various string-to-hexadecimal converters are available on the Internet.</p> </div> <p>Enter the encryption key in 2-character hexadecimal combinations in lines 00 to 07 in the lines provided.</p> <pre style="border: 1px solid gray; padding: 5px; margin: 10px 0;"> Enter Choice e 0=Off, 2=AES128, 3=AES192, 4=AES256, 5=Enter Key 6=Channel Key 00 12 01 af 02 21 03 43 04 51 05 ab 06 Ac 07 cD </pre>

5.3.4. Troubleshooting AES Setup

The radios link, transmit data, and then unlink.

- Verify that the **MCU Speed** parameter is set to **3** in the terminal interface.

The radios link, transmit data, but the data is in unrecognizable characters.

- Verify that the **Encryption Key** on each radio is set exactly the same. If the keys do not match, the radios can still transmit data, but cannot decrypt the data.

The radios do not link and the golden settings are all set the same.

- Verify that the **Channel Key** in the Encryption menu is set the same across the radios in the network. If the keys do not match, the radios will not link when AES is enabled, even if the golden settings match.

5.4. Low Baud Rates

The radio's Baud Rate may be set to 300, 600, or 900.

Note: For more information about using a low baud rate, [Contact FreeWave Technical Support \(on page 9\)](#).

5.5. Multi-Master Sync

The **Multi-Master Sync** setting is reserved for applications in both Point-to-Point and MultiPoint modes with concentrations of Master units where it is necessary to reduce interference between the Master radios.

- For more information about using **Multi-Master Sync** in non-TDMA mode, see **Application Note #5412, Synchronizing Collocated Masters**.

Note: For more information about using **Multi-Master Sync** while in TDMA mode, contact FreeWave Technical Support.
See [Contact FreeWave Technical Support \(on page 9\)](#).

6. Viewing Radio Statistics

When reading a radio, the system shows data transmission statistics the radio has gathered during the most recent session. This information is valuable to know the signal strength and noise levels of the link. Statistics are gathered during each time the Master and Slave link and are reset when the next link begins.

More data transmission characteristics are available, including averages gathered over time, in the **Network Diagnostics** application.

Note: For information about running network diagnostics see the Tool Suite User Manual.

- [Antenna Reflected Power \(on page 105\)](#)
- [Noise Level \(on page 105\)](#)
- [Number of Disconnects \(on page 105\)](#)
- [Radio Temperature \(on page 105\)](#)
- [Rate % \(Receive Percentage Rate\) \(on page 105\)](#)
- [Signal Level \(on page 106\)](#)
- [Transmit Current \(on page 106\)](#)

6.1. Antenna Reflected Power

Note: This statistic is not valid in the MM3-LV-T, MM3-T radios.

6.2. Noise Level

The **Noise Level** indicates the level of background noise and interference at this radio and at each of the Repeaters in the link. The number is an average of the noise levels measured at each frequency in the radio's frequency hop table.



The individual measurement values at each frequency hop channel are shown in the [900MHz Frequency Zones Table \(on page 50\)](#).

If viewing statistics in the terminal interface, press <Enter> when the **Radio Statistics** menu appears.

- Ideally, the difference between the average signal level and average noise level should be **15** or more.
- Margins that are significantly higher than this are an indication of a high level of interference that may degrade the performance of the link.

6.3. Number of Disconnects

The value in this statistic indicates the total number of times the link between the Master and the Slave has been lost and the radios lose **Carrier Detect** from the time the radio is powered on until the radio is put into **Setup** mode.

- Under ideal operating conditions, the number of disconnects should be **0**.
- One or more disconnects may indicate a weak link, the presence of severe interference problems, or loss of power to any of the radios in the link.

Note: In Tool Suite, the disconnect information is available in the **Summary View** under **Network Diagnostics**.

6.4. Radio Temperature

The **Radio Temperature** value is the current operating temperature of the radio in degrees Celsius.

6.5. Rate % (Receive Percentage Rate)

The **Rate %** measures the percentage of data packets that were successfully transmitted from the Master and received by the upstream radio on the first attempt. The rate percentage represents only what the upstream radio received.

- A number of 75 or higher indicates a robust link that provides very good performance even at high data transmission rates.

- A number of 15 or lower indicates a weak or marginal link that provides lower data throughput.
- Throughput is reduced by 50 percent if the network contains a Repeater.

Note: Many settings can impact actual throughput, including **Master Packet Repeat** and **Max Slave Retry**.

If the link is asymmetrical, the percentage reported in this statistic can be very high, and the uplink can still be poor.

6.6. Signal Level

The **Signal Level** indicates the level of received signal at the radio and at each of the Repeaters in the link.

- The source of the signal is the radio that transmits to the radio reading this statistic.
- The number is an average of the received signal levels measured at each frequency in the radio's frequency hop table.
- For a reliable link, the margin should be at least 15 dB.
- Low average signal levels can often be corrected with higher gain antennas, better antenna placement and/or additional Repeaters.



The individual measurement values at each frequency hop channel are shown in the [900MHz Frequency Zones Table \(on page 50\)](#).

If viewing statistics in the terminal interface, press <Enter> when the **Radio Statistics** menu appears.

6.7. Transmit Current

Note: This statistic is not valid in the MM3-T radios.

7. MM3-T Wireless Data Radios

Pinouts

7.1. Operational RS422 Information

A maximum of 256 devices can be tied on the bus if all of the line receivers have 1/8 unit load.

- RS-422 is used for 4-wire or full duplex communications with one Master radio and multiple Slave radios.
- The Master radio keeps the line driver asserted at all times.
- The maximum line length is 4,000 feet using two, 120 ohm twisted pair cables with a 5th wire for data common.

7.2. Pinout Assignments and Descriptions

- [MM3-T Board-Level Pinout](#)

7.3. MM3-T Board-Level Pinout

- J1 - 14 pin, 2.00 mm centers, Samtec TMM series, TMM-107-01-**G-D-SM-option**
- Mates with Samtec CLT, SMM, MMS, SQT, ESQT, SQW, TLE, TCSD, TLSD series.

Note: [Figure 31](#) identifies pin the numbers.

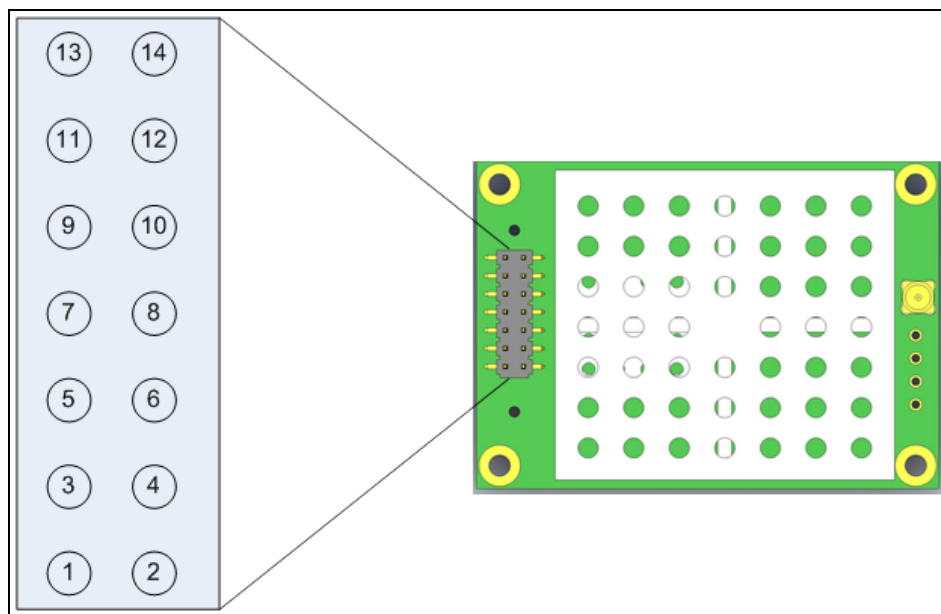

Figure 31: MM3-T Board-Level Pinout

MM3-T Board-Level Pinout				
Pin	Input/Output	Description	Label	Notes
1	Input	Power	B+	
2	Input	Reset	Interrupt	Active Low 100 μ s pulse
3	Input	Data Terminal Ready	DTR	TTL ²
4	Ground	Ground	GND	
5	Output	Transmitted Data	TXD	0 to 3.3 V TTL ¹
6	Output	RSSI Out	RSSI	Currently not functional
7	input	Received Data	RXD	TTL ²
8	Output	Carrier Detect	CD	0 to 3.3 V TTL ¹
9	Input	Request To Send	RTS	TTL ²
10	Output	Clear To Send	CTS	0 to 3.3 V TTL ¹

MM3-T Board-Level Pinout				
Pin	Input/Output	Description	Label	Notes
11	Input	Diagnostic Received Data	Diag RX	TTL ³
12	Output	Diagnostic Transmitted Data	Diag TX	0 to 3.3 V TTL ¹
13	Ground	Ground	GND	
14	Output	Baud Clock	Baud Clock	

1. 3.3 V output assumes greater than 3.3 V input voltage. At 3 V input voltage, signal will be 0 to 3 V TTL.
2. 0 to 5 V TTL, 330 Ω resistor in series.
3. 0 to 5 V TTL

8. Troubleshooting

If experiencing trouble with the network, see these sections to initially troubleshoot and help identify the problem with the network or a radio within it:

- LEDs on the radio.
 - [Point-to-MultiPoint Operation LEDs \(on page 67\)](#).
 - [Point-to-Point Operation LEDs \(on page 89\)](#).
- Settings
- RF Quality

Use the [Troubleshooting Flowchart \(on page 113\)](#) for basic checks to help diagnose the issue.

Note: [Contact FreeWave Technical Support \(on page 9\)](#) for assistance.

8.1. Troubleshooting Flowchart

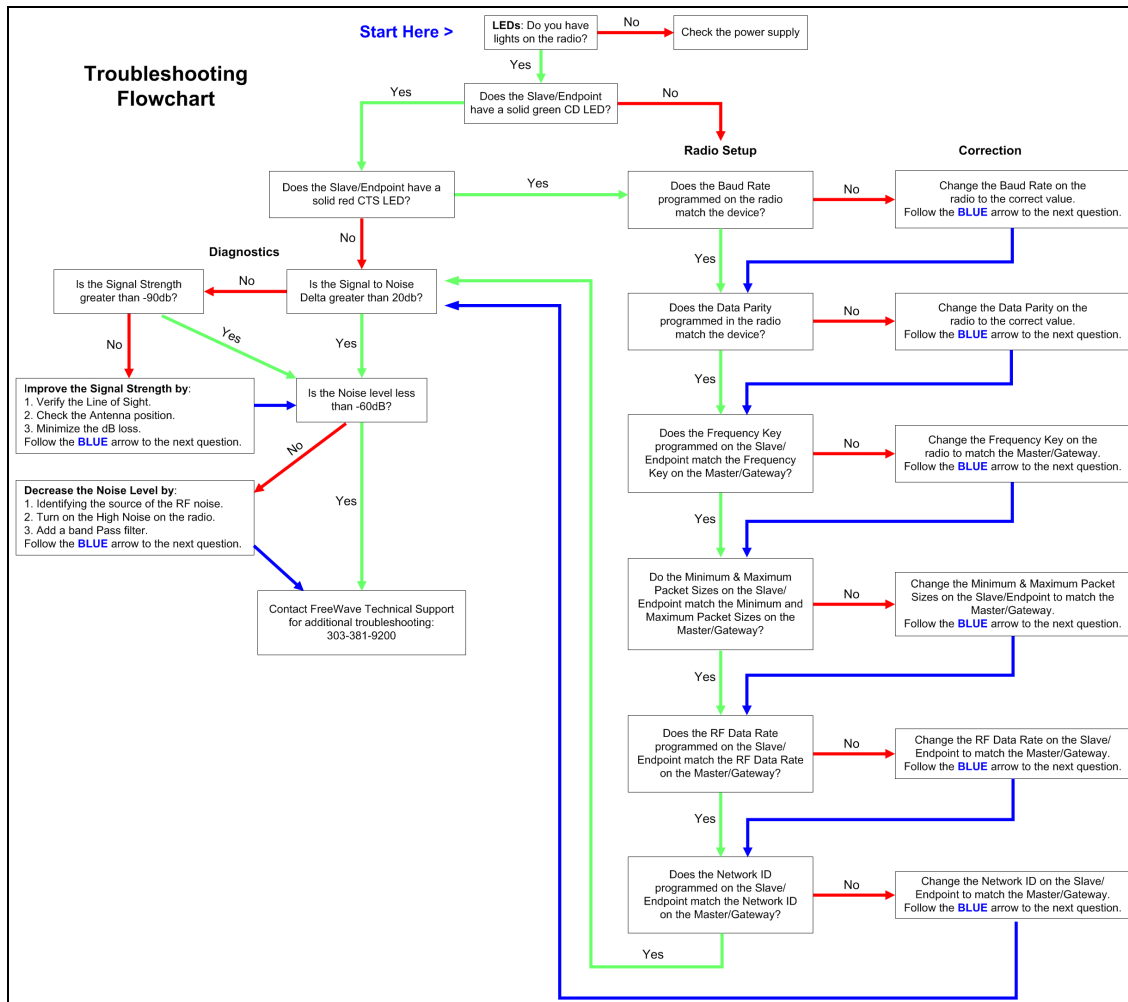

9. MM3-T Release Notes

These sections describe the updates and known limitations in each software version for the MM3-T Wireless Data Radios. The most recent version is listed first.



The latest software versions and the most recent list of known limitations and workarounds are available on www.freewave.com.

Important!: Some earlier firmware versions may not be available on all MM3 models.

9.1. Version v11.00.11 (Initial Release)

Release date: March 2020

Appendix C: MM3-T Technical Specifications

MM3-T and Technical Specifications	
Specification	Description
Transmitter	
Frequency Range	<ul style="list-style-type: none"> • 902 to 928 MHz • China: 920.5 to 924.5Mhz
Output Power	Up to 1 W
Range	Up to 32 km (20 mi.), clear line of sight <div style="border: 1px solid black; padding: 5px; margin-top: 10px;"> <p>Note: Using Omni to Omni antenna connection, with clear line of sight and no diffraction loss.</p> </div>
Channel Spacing	<ul style="list-style-type: none"> • 230.4 kHz • China: 230 Khz <div style="border: 1px solid black; padding: 5px; margin-top: 10px;"> <p>Note: applicable to FCC KNYMM3 and IC ID: 2329B-MM3</p> </div>
RF Data Rate	115.2 or 153.6 kbps, User selectable
Receiver	
Sensitivity	<ul style="list-style-type: none"> • -108 dBm @ 115.2 kbps for BER 10⁻⁴ • -103 dBm @ 153.6 kbps for BER 10⁻⁴
IF Selectivity	40 dB at fc +/- 230 kHz

MM3-T Technical Specifications				
Specification	Description			
RF Selectivity	50 dB at 896 MHz, 935 MHz			
Dynamic Range	+10 dBm 3 rd order intercept point at input connector			
Data Transmission				
Type	Frequency Hopping Spread Spectrum Options: TDMA, Super Epoch TDMA			
Modulation	2 level GFSK			
Data Throughput	80 or 115.2 kbps			
Error Detection	32-bit CRC, retransmit on error			
Data Encryption	Options AES 128, 192, 256-bit encryption*			
	<div style="border: 1px solid black; padding: 5px;"> <p>Note: * Contact a FreeWave reseller or sales representative for implementation details.</p> </div>			
Hopping Zones	16 zones, User selectable			
Hopping Bands	7 bands, User selectable			
Hopping Channels	<ul style="list-style-type: none"> • 50 to 110, User selectable • China: 80 to 100, User selectable 			
	<div style="border: 1px solid black; padding: 5px;"> <p>Note: applicable to FCC KNYMM3 and IC ID: 2329B-MM3</p> </div>			
Hopping Patterns	<ul style="list-style-type: none"> • 15 per band, • 105 total, • User selectable 			
Protocol	TTL			
Power Requirements				
Operating Voltage	+1.8 to +5.0 VDC (+/- 5%)			
Current Consumption	Voltage	Transmit	Receive	Idle
	5.0 VDC	855 mA	90 mA	21 mA
Interfaces				
Data Interface	<ul style="list-style-type: none"> • 14-pin straight, dual-row header for power, data, and diagnostics • 2mm pin spacing 			
Diagnostics Interface	TTL Serial			
RF Connector	MMCX			
General Information				

MM3-T Technical Specifications	
Specification	Description
Operating Temperature	<ul style="list-style-type: none">• -40°C to +85°C• -40°F to 185°F
Humidity	0 to 95% non-condensing
Dimensions	<ul style="list-style-type: none">• 50.8 L x 36.1 W x 9.4 (mm)• 2.0 L x 1.42 W x 0.37 H (in)
Weight	14g (0.49 oz)

(Intentionally left blank)

Appendix E: MM3-T Mechanical Drawing

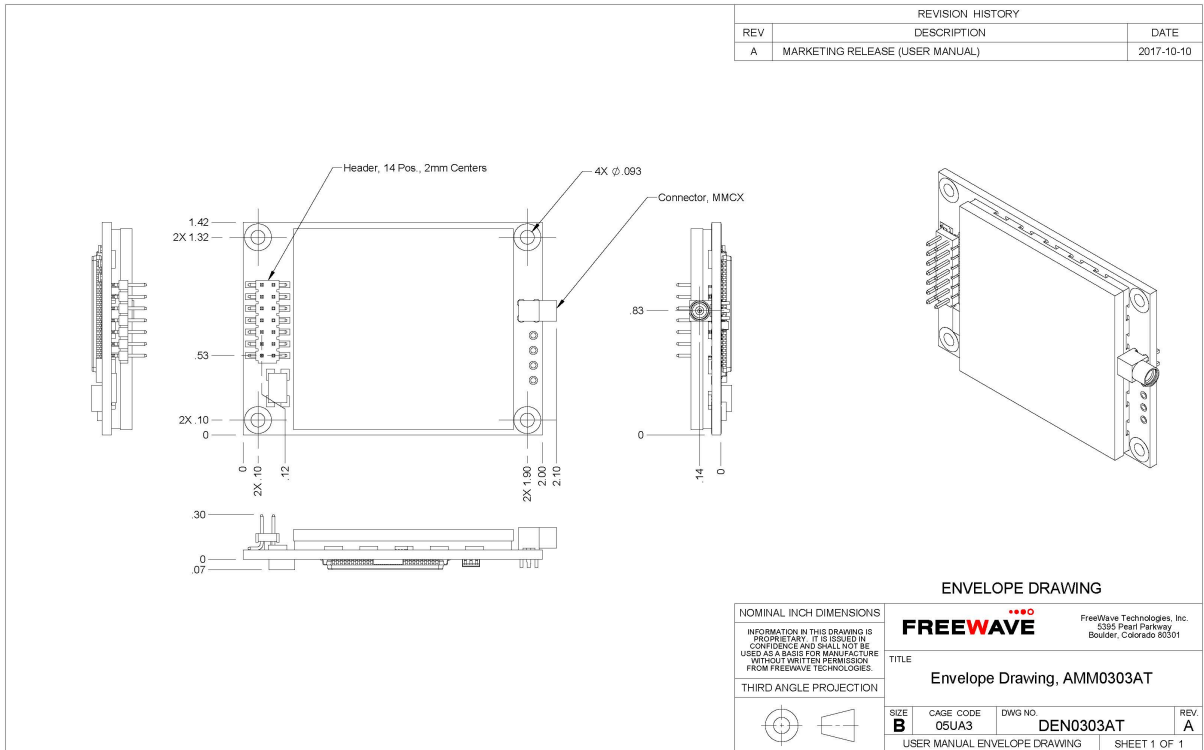

Appendix F: 900MHz Factory Default Settings

900MHz Factory Default Settings			
Operation Mode	Default	MultiPoint Parameters	Default
Point-to-Point Slave	1	(0) Number of Repeaters	1
Set Baud Rate	Default	(1) Master Packet Repeat	2
Baud Rate	115200	(2) Max Slave Retry	9
(A) Data Parity	0	(3) Retry Odds	9
(B) Modbus RTU	0	(4) DTR Connect	0
(C) RS232/485	0	(5) Repeatr Frequency	0
(D) Setup Port	3	(6) Network ID	255
(E) Turn Off Delay / On Delay	0/0	(7) Reserved	-
(F) Flow Control	0	(8) MultiMaster Sync	0
Radio Parameters	Default	(9) 1 PPS Enable Delay	255
(0) Freq Key	5	(A) Slave/Repeater	0
(0) Hop Table Version	0	(B) Diagnostics	0
(1) Hop Table Size	111	(C) Subnext ID	"Disabled"
(2) Hop Freq Offset	0	Rx ID	F
(3) Frequency Zone	All 1s (Enabled)	Tx ID	F
(4) Government Rules	0	(D) Radio ID	Not Set
(1) Max Packet Size	8	(E) Local Access	0
(2) Min Packet Size	9	(G) Radio Name	"blank"

900MHz Factory Default Settings			
Operation Mode	Default	MultiPoint Parameters	Default
(3) Xmit rate	1		
(4) RF Data Rate	3		
(5) RF Xmit Power	10		
(6) Slave Security	0		
(7) RTS to CTS	0		
(8) Retry Timeout	255		
(9) Low Power Mode	0		
(A) High Noise	0		
(B) MCU Speed	0		
(C) Remote LED	0		
(E) Encryption			
Strength	(0) Off		
Enter Key	Blank		
Channel Key	Blank		

Appendix G: 900MHz Channel Frequency IDs

Note: See [900MHz Channel Select Parameters \(on page 45\)](#) for additional information.

900MHz Channel Frequency IDs							
ID	Frequency		ID	Frequency		ID	Frequency
0	902.2464		40	911.4624		80	920.6784
1	902.4768		41	911.6928		81	920.9088
2	902.7072		42	911.9232		82	921.1392
3	902.9376		43	912.1536		83	921.3696
4	903.1680		44	912.3840		84	921.6000
5	903.3984		45	912.6144		85	921.8304
6	903.6288		46	912.8448		86	922.0608
7	903.8592		47	913.0752		87	922.2912
8	904.0896		48	913.3056		88	922.5216
9	904.3200		49	913.5360		89	922.7520
10	904.5504		50	913.7664		90	922.9824
11	904.7808		51	913.9968		91	923.2128
12	905.0112		52	914.2272		92	923.4432
13	905.2416		53	914.4576		93	923.6736
14	905.4720		54	914.6880		94	923.9040
15	905.7024		55	914.9184		95	924.1344

900MHz Channel Frequency IDs							
ID	Frequency		ID	Frequency		ID	Frequency
16	905.9328		56	915.1488		96	924.3648
17	906.1632		57	915.3792		97	924.5952
18	906.3936		58	915.6096		98	924.8256
19	906.6240		59	915.8400		99	925.0560
20	906.8544		60	916.0704		100	925.2864
21	907.0848		61	916.3008		101	925.5168
22	907.3152		62	916.5312		102	925.7472
23	907.5456		63	916.7616		103	925.9776
24	907.7760		64	916.9920		104	926.2080
25	908.0064		65	917.2224		105	926.4384
26	908.2368		66	917.4528		106	926.6688
27	908.4672		67	917.6832		107	926.8992
28	908.6976		68	917.9136		108	927.1296
29	908.9280		69	918.1440		109	927.3600
30	909.1584		70	918.3744		110	927.5904
31	909.3888		71	918.6048		111	927.8208
32	909.6192		72	918.8352			
33	909.8496		73	919.0656			
34	910.0800		74	919.2960			
35	910.3104		75	919.5264			
36	910.5408		76	919.7568			
37	910.7712		77	919.9872			
38	911.0016		78	920.2176			
39	911.2320		79	920.4480			

Appendix I: FreeWave Legal Information

Restricted Rights

Any product names mentioned in this manual may be trademarks or registered trademarks of their respective companies and are hereby acknowledged.

This manual is for use by purchasers and other authorized users of FreeWave products.

No part of this manual may be reproduced or transmitted in any form or by any means, electronic or mechanical, or for any purpose without the express written permission of FreeWave Technologies, Inc. FreeWave reserves the right to make changes to this manual without notice. FreeWave assumes no responsibility or liability for the use of this manual or the infringement of any copyright or other proprietary right.

FreeWave products are designed and manufactured in the United States of America.

Export Notification

FreeWave Technologies, Inc. products may be subject to control by the Export Administration Regulations (EAR) and/or the International Traffic in Arms Regulations (ITAR). Export, re-export, or transfer of these products without required authorization from the U.S. Department of Commerce, Bureau of Industry and Security, or the U.S. Department of State, Directorate of Defense Trade Controls, as applicable, is prohibited. Any party exporting, re-exporting, or transferring FreeWave products is responsible for obtaining all necessary U.S. government authorizations required to ensure compliance with these and other applicable U.S. laws. Consult with your legal counsel for further guidance.

Information, Science and Economic Development Canada (ISED) Notification:

This device complies with part 15 of the FCC rules. Operation is subject to the following two conditions: 1) This device may not cause harmful interference and 2) this device must accept any interference received, including interference that may cause undesired operation.

The content of this guide covers FreeWave Technologies, Inc. models sold under FCC ID: KNYMM3 All models sold under the FCC ID(s) listed above must be installed professionally and are only approved for use when installed in devices produced by FreeWave Technologies or third party OEMs with the express written approval of FreeWave Technologies, Inc. Changes or modifications should not be made to the device. When the Host (OEM) is integrating the subject device via a modular certification, the host is required to label their product with:

Contains FCC ID: KNYMM3 and IC: 2329B-MM3.

The Host is also responsible for complete product compliance testing meeting the requirements for part 15.

Caution: changes or modifications not expressly approved by FreeWave could void the user's authority to operate the equipment

UL Notifications / Warnings - Class1 Div2



Warning! EXPLOSION HAZARD! . DO NOT CONNECT OR DISCONNECT WHEN ENERGIZED.'

'AVERTISSEMENT – RISQUE D'EXPLOSION. NE PAS BRANCHER NI DÉBRANCHER SOUS TENSION.



Warning! DO NOT REMOVE or insert the diagnostics cable while the circuit is live!

UL Power Source

Important!: Input power shall be derived from a single Class 2 power source.



- Models MM3-T are suitable for use in Class 1, Division 2, Groups A, B, C, and D or non-hazardous locations only.
- Input voltage for the MM3-T models is +1.8 to +5.0 VDC.

Nonincendive Electrical Equipment for Use in Class I and II, Division 2 and Class III, Divisions 1 and 2 Hazardous (Classified) Locations [UL 121201:2017 Ed.9+R:01Apr2021]

Nonincendive Electrical Equipment for Use in Class I and II, Division 2 and Class III, Divisions 1 and 2 Hazardous (Classified) Locations [CSA C22.2#213:2017 Ed.3+U1;U2;U3]

Audio/Video, Information and Communication Technology Equipment - Part 1: Safety Requirements [UL 62368-1:2019 Ed.3]

Audio/Video, Information and Communication Technology Equipment - Part 1: Safety Requirements [CSA C22.2#62368-1:2019 Ed.3]

FCC Notifications

This device complies with part 15 of the FCC rules. Operation is subject to the following two conditions: 1) This device may not cause harmful interference and 2) this device must accept any interference received, including interference that may cause undesired operation.

The content of this guide covers FreeWave Technologies, Inc. models sold under FCC ID: KNYMM3

All models sold under the FCC ID(s) listed above must be installed professionally and are only approved for use when installed in devices produced by FreeWave Technologies or third party OEMs with the express written approval of FreeWave Technologies, Inc. Changes or modifications should not be made to the device.

The antenna(s) used for this transmitter must be installed to provide a separation distance of at least 33.2cms from all persons and must not be collocated or operating in conjunction with any other antenna or transmitter within a host device, except in accordance with FCC multi-transmitter product procedures.

“Attention ! Le émetteur radio traité dans ce guide a une puissance de sortie maximale de 1 W. Lors de l’installation et de l’utilisation de cet émetteur, une distance de separation minimale de 33.2 cm doit être conservée entre l’antenne et votre corps. Cet émetteur ne doit pas être placé ou utilisé en conjonction avec d’autres antennes ou émetteurs. “

FCC NEMA Installation and Label

Where applicable, the models described in this guide must be installed in a NEMA enclosure. When any FreeWave Technologies, Inc. module is placed inside an enclosure, a label must be placed on the outside of the enclosure. The label must include the text "**Contains Transmitter Module with FCC ID: KNYMM3 and IC:2329B-MM3.**"

ISED Notification

“This radio transmitter 2329B-MMS has been approved by Innovation, Science and Economic Development Canada to operate with the antenna types listed below, with the maximum permissible gain indicated. Antenna types not included in this list that have a gain greater than the maximum gain indicated for any type listed are strictly prohibited for use with this device.”

“Le présent émetteur radio 2329B-MM3 a été approuvé par Innovation, Sciences et Développement économique Canada pour fonctionner avec les types d’antenne énumérés ci-dessous et ayant un gain admissible maximal. Les types d’antenne non inclus dans cette liste, et dont le gain est supérieur au gain maximal indiqué pour tout type figurant sur la liste, sont strictement interdits pour l’exploitation de l’émetteur. “

Appendix I: FreeWave Legal Information

Type	Maximum Gain (dBi)	Impedance (Ohms)
Yagi	12	50
Omni	8.15	50



Warning! If the device you are installing contains a radio with FCC ID KNYMM3 on the label, you are restricted to using only antennas with 12dBi gain or less.



Warning! The radios covered in this guide have a maximum transmitted output power of 1 W. The antennas used must provide a separation distance of at least 33.2 cm from all persons and must not be co-located or operate in conjunction with any other antenna or transmitter.



FREEWAVE